

PIANCA

**+14%**

dal / from 05.09.2022

# Novità accessori e finiture interni armadio

## <sup>EN</sup> New wardrobe interior accessories and finishes

SIPARIO, ANTEPRIMA, ISLAND

**PRICE LIST REPLACING:**  
WARDROBES AND WALK-IN CLOSETS  
Price List 03rd April 2021

- |  |                      |
|--|----------------------|
| • Sipario internal accessories               | from page 187 to 206 |
| • Anteprema drawer units cubbies accessories | from page 240 to 249 |
| • Island                                     | from page 264 to 269 |
| • Accessories                                | from page 270 to 274 |

PIANCA



# INDEX

---

## CATALOGUE

Standard Drawer units	2
Metal Drawer units	4
Miro Metal Drawer units	6
Pull-out frames	8
Island	10

## PRICELIST

### INTERNAL ACCESSORIES

Characteristics and finishes	15
Wooden shelves	16
Hanging rods	17
Glass shelves	17
Wooden cubbies	18
Shelves with syntyhetic leather inserts and backlit glass	19
LED lights	20
Accessories	21
Internal mirrors	23
Partitions	24
Floor sitting T partitions for drawer units	25
Standard Drawer units	27
Metal Drawer units	30
Miro Metal Drawer units	33
Pull-out frames and accessories	34

### ANTEPRIMA, DRAWER UNITS, CUBBIES AND ACCESSORIES

Standard Drawer units	37
Metal Drawer units	41
Miro Metal Drawer units	45
Hanging cubbies	46
Pull-out frames and accessories	47

### ISLAND

Island	49
Display case and trays for double Island	51
Display case and trays for single Island	52

### ACCESSORIES

Wooden accessories	54
Bottoms and boxes	56
Internal accessories for drawers	57

# Cassettiere standard

## EN Standard drawer units

Sipario / Anteprima

Finiture  
EN Finishes

Struttura,  
EN Structure

Materico, EN Materico:  
522 Borgogna,  
518 Noce Dorato,  
520 Larice Tortora,  
501 Bon Ton,  
Perlage Terra,  
Perlage Congliolia

Laccato Opaco Duna\*\*,  
EN Duna Matt Lacquered\*\*

Frontale, EN Front

Materico, EN Materico:  
522 Borgogna,  
518 Noce Dorato,  
520 Larice Tortora,  
501 Bon Ton,  
Perlage Terra,  
Perlage Congliolia

Laccato Opaco Duna\*\*,  
EN Duna Matt Lacquered\*\*

Vetro, EN Glass:  
Laccato Opaco o Lucido,  
EN Matt or Glossy lacquered,  
Metallizzato

Vetro Marmo, EN Marble  
Glass: Calacatta, Amani,  
Sahara

Specchio, EN Mirror:  
Argento, Piombo, Bronzo

Pelle Sintetica,  
EN Synthetic Leather:  
Creta, Elephant, Talpa,  
Bacca, Cactus

\*\*Disponibile in tutti i  
colori laccati opachi della  
collezione, EN Available in  
all the matt lacquered  
colours of our collection



## PIANCA

## Sistemi Notte EN Night Systems

### Sipario

\* Disponibile anche con P 42.3 per Sipario e 39.5 per Anteprima  
\* EN Available also for D 16.65" for Sipario and for D 15.55" for Anteprima

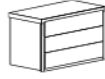

A terra  
EN Floor sitting

H 43\* cm 2 cassetti,  
EN H 16.93"\* 2 drawers

H 49 cm 2 cassetti,  
EN H 19.29" 2 drawers

H 64 cm 3 cassetti,  
EN 25.20" 3 drawers

H 71 cm 3 cassetti,  
EN H 27.95" 3 drawers

H 81\* cm 4 cassetti,  
EN H 31.89"\* 4 drawers

H 88 cm 4 cassetti,  
EN H 34.64" 4 drawers

H 103 cm 5 cassetti,  
EN H 40.55" 5 drawers

H 120 \* cm 6 cassetti,  
EN H 47.24"\* 6 drawers

L 57.8 - 67.8 - 97.8  
117.8 - 137.8 - 147.8 cm  
P 42.3\* - 59 cm

W 22.75" - 26.69" - 38.50"  
- 46.38" - 54.25" - 58.19"  
D 16.65"\* - 23.23"

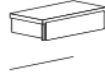

Pensile  
EN Hanging

H 22 cm 1 cassetto,  
EN H 8.66" 1 drawer

H 38\* cm 2 cassetti,  
EN H 14.96\* 2 drawers

L 57.8 - 67.8 - 97.8  
117.8 - 137.8 - 147.8 cm  
P 42.3\* - 59 cm

W 22.75" - 26.69" - 38.50"  
- 46.38" - 54.25" - 58.19"  
D 16.65"\* - 23.23"

### Anteprima



Autoportante  
EN Freestanding

H 44\* cm 2 cassetti,  
EN H 17.32" 2 drawers

H 82 cm 4 cassetti,  
EN H 32.28" 4 drawers

L 50 - 70 - 90 - 110 cm  
P 39.5\* - 51 cm

W 19.68" - 27.56" - 35.43"  
- 43.31"  
D 15.55"\* - 20.08"

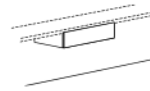

Pensile  
EN Hanging

H 17 cm 1 cassetto,  
EN H 6.69" 1 drawer

H 36\* cm 2 cassetti,  
EN H 14.17"\* 2 drawers

L 50 - 70 - 90 - 110 cm  
P 39.5\* - 51 cm

W 19.68" - 27.56" - 35.43"  
- 43.31"  
D 15.55"\* - 20.08"

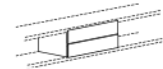

Sottopiano  
EN Under shelf

H 36\* cm 2 cassetti,  
EN H 14.17"\* 2 drawers

H 74 cm 4 cassetti,  
EN H 29.13" 4 drawers

H 112 cm 6 cassetti,  
EN H 44.09" 6 drawers

L 50 - 70 - 90 - 110 cm  
P 39.5\* - 51 cm

W 19.68" - 27.56" - 35.43"  
- 43.31"  
D 15.55"\* - 20.08"

Dettaglio frontale materico Larice Tortora e pelle sintetica Cactus,  
EN Detail of drawer front in materico Larice Tortora and Cactus synthetic leather



Dettaglio frontale in materico Perlage Terra,  
EN Detail of drawer front in Materico Perlage Terra



# Cassettiere Metallo

## EN Metal drawer units

Sipario / Anteprima

Finiture  
EN Finishes

Struttura,  
EN Structure

Materico, EN Materico:  
522 Borgogna,  
518 Noce Dorato,  
520 Larice Tortora,  
501 Bon Ton,  
Perlage Terra,  
Perlage Congliiglia

Laccato Opaco Duna\*\*,  
EN Duna Matt Lacquered\*\*

Frontale, EN Front

Materico, EN Materico:  
522 Borgogna,  
518 Noce Dorato,  
520 Larice Tortora,  
501 Bon Ton,  
Perlage Terra,  
Perlage Congliiglia

Laccato Opaco Duna\*\*,  
EN Duna Matt Lacquered\*\*

Vetro, EN Glass:  
Laccato Opaco o Lucido,  
EN Matt or Glossy lacquered,  
Metallizzato

Vetro Marmo, EN Marble  
Glass: Calacatta, Amani,  
Sahara

Specchio, EN Mirror:  
Argento, Piombo, Bronzo

Pelle Sintetica,  
EN Synthetic Leather:  
Creta, Elephant, Talpa,  
Bacca, Cactus

Fondo cassetto,  
EN Drawer bottom

Vetro, EN Glass:  
Trasparente Piombo

Laccato Opaco Duna\*\*,  
EN Duna Matt Lacquered\*\*

Materico, EN Materico

\*\*Disponibile in tutti i colori laccati opachi della collezione, EN Available in all the matt lacquered colours of our collection



## PIANCA

## Sistemi Notte EN Night Systems

### Sipario

\* Disponibile anche con  
P 42.3 per Sipario e 39.5  
per Anteprima  
\* EN Available also for  
D 16.65" for Sipario and  
for D 15.55" for Anteprima



A terra  
EN Floor sitting

H 43\* cm 2 cassetti,  
EN H 16.93"\* 2 drawers

H 49 cm 2 cassetti,  
EN H 19.29" 2 drawers

H 64 cm 3 cassetti,  
EN 25.20" 3 drawers

H 71 cm 3 cassetti,  
EN H 27.95" 3 drawers

H 81\* cm 4 cassetti,  
EN H 31.89"\* 4 drawers

H 88 cm 4 cassetti,  
EN H 34.64" 4 drawers

H 103 cm 5 cassetti,  
EN H 40.55" 5 drawers

H 120 \* cm 6 cassetti,  
EN H 47.24"\* 6 drawers

L 67.8 - 97.8 - 117.8 cm  
P 42.3 \*- 59 cm

W 26.69" - 38.50" - 46.38"  
D 16.65"\* - 23.23"

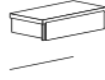

Pensile  
EN Hanging

H 22 cm 1 cassetto,  
EN H 8.66" 1 drawer

H 38\* cm 2 cassetti,  
EN H 14.96\* 2 drawers

L 67.8 - 97.8 - 117.8 cm  
P 42.3 \*- 59 cm

W 26.69" - 38.50" - 46.38"  
D 16.65"\* - 23.23"



Autoportante  
EN Freestanding

H 44\* cm 2 cassetti,  
EN H 17.32" 2 drawers

H 82 cm 4 cassetti,  
EN H 32.28" 4 drawers

L 70 - 90 - 110 cm  
P 39.5\* - 51 cm

W 27.56" - 35.43" - 43.31"  
D 15.55"\* - 20.08"

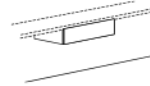

Pensile  
EN Hanging

H 17 cm 1 cassetto,  
EN H 6.69" 1 drawer

H 36\* cm 2 cassetti,  
EN H 14.17"\* 2 drawers

L 70 - 90 - 110 cm  
P 39.5\* - 51 cm

27.56" - 35.43" - 43.31"  
D 15.55" - 20.08"

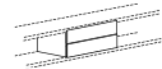

Sottopiano  
EN Under shelf

H 36\* cm 2 cassetti,  
EN H 14.17"\* 2 drawers

H 74 cm 4 cassetti,  
EN H 29.13" 4 drawers

H 112 cm 6 cassetti,  
EN H 44.09" 6 drawers

L 70 - 90 - 110 cm  
P 39.5\* - 51 cm

W 27.56" - 35.43" - 43.31"  
D 15.55"\* - 20.08"

Dettaglio fondo cassetto in  
vetro Trasparente Piombo,  
EN Detail of drawer  
bottom in Transparent  
Piombo glass



# Cassettiere Metallo Miro

## EN Miro Metal drawer units

Sipario / Anteprima

---

**Finiture**  
EN Finishes

---

**Struttura,**  
EN Structure

Materico, EN Materico:  
522 Borgogna,  
518 Noce Dorato,  
520 Larice Tortora,  
501 Bon Ton,  
Perlage Terra,  
Perlage Congliolia

Laccato Opaco Duna\*\*,  
EN Duna Matt Lacquered\*\*

**Frontale,** EN Front

Vetro, EN Glass:  
Riflettente, Trasparente,  
Trama

**Cornice,** EN Frame

Canna di Fucile

**Fondo cassetto,**  
EN Drawer bottom

Vetro, EN Glass:  
Trasparente Piombo

Laccato Opaco Duna\*\*,  
EN Duna Matt Lacquered\*\*

Materico, EN Materico

\*\*Disponibile in tutti i  
colori laccati opachi della  
collezione, EN Available in  
all the matt lacquered  
colours of our collection





## PIANCA

## Sistemi Notte EN Night Systems

### Sipario

\* Disponibile anche con  
P 42.3 per Sipario e 39.5  
per Anteprima  
\* EN Available also for  
D 16.65" for Sipario and  
for D 15.55" for Anteprima



A terra  
EN Floor sittin

H 43\* cm 2 cassetti,  
EN H 16.93"\* 2 drawers

H 64 cm 3 cassetti,  
EN 25.20" 2 drawers

H 81\* cm 4 cassetti,  
EN H 31.89"\* 4 drawers

H 103 cm 5 cassetti,  
EN H 40.55" 5 drawers

H 120 \* cm 6 cassetti,  
EN H 47.24"\* 6 drawers

L 67.8 - 97.8 - 117.8 cm  
P 42.3 \*- 59 cm

W 26.69"-38.50"- 46.38"  
D 16.65"\* - 23.23"



Pensile  
EN Hanging

H 22 cm 1 cassetto,  
EN H 8.66" 1 drawer

H 38\* cm 2 cassetti,  
EN H 14.96\* 2 drawers

L 67.8 - 97.8 - 117.8 cm  
P 42.3 \*- 59 cm

W 26.69"-38.50"- 46.38"  
D 16.65"\* - 23.23"

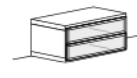

Autoportante  
EN Freestanding

H 44\* cm 2 cassetti,  
EN H 17.32"\* 2 drawers

H 82 cm 4 cassetti,  
EN H 32.28" 2 drawers

L 70 - 90 - 110 cm  
P 39.5\* - 51 cm

W 27.56" - 35.43" - 43.31"  
D 15.55" - 20.08"

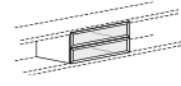

Sottopiano  
EN Under shelf

H 36 cm 2 cassetti,  
EN H 14.17" 3 drawers

H 74 cm 4 cassetti,  
EN H 29.13" 4 drawers

H 112 cm 6 cassetti,  
EN H 44.09" 6 drawers

L 70 - 90 - 110 cm  
P 51 cm

W 27.56" - 35.43" - 43.31"  
D 20.08"

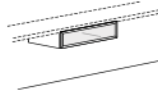

Pensile  
EN Hanging

H 17 cm 1 cassetto,  
EN H 6.69" 1 drawer

H 36 cm 2 cassetti,  
EN H 14.17" 3 drawers

L 70 - 90 - 110 cm  
P 51 cm

W 27.56" - 35.43" - 43.31"  
D 20.08"

Dettaglio fondo cassetto  
in Materico 501 Bon Ton  
EN Detail of drawer  
bottom in Materico 501  
Bon Ton



# Telai estraibili

## EN Pull-out frames

Sipario / Anteprima

---

Finiture  
EN Finishes

---

Telaio, EN Frame

Canna di Fucile

Distanziale e frontalino,  
EN Front and spacer

Materico, EN Materico:  
522 Borgogna,  
518 Noce Dorato,  
520 Larice Tortora,  
501 Bon Ton,  
Perlage Terra,  
Perlage Congliola

Laccato Opaco Duna\*\*,  
EN Duna Matt Lacquered\*\*

\*\*Disponibile in tutti i  
colori laccati opachi della  
collezione, EN Available in  
all the matt lacquered  
colours of our collection



## PIANCA

## Sistemi Notte EN Night Systems

### Sipario

### Anteprima

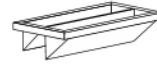
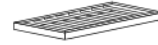
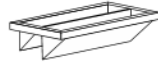
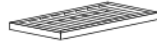

**Portapantaloni**  
EN Trouser rack

**Portascarpe in lamiera**  
EN Metal shoe rack

**Portapantaloni**  
EN Trouser rack

**Portascarpe in lamiera**  
EN Metal shoe rack

H 6  
L 67.8 - 97.8 - 117.8 cm  
P 59 cm

H 15  
L 67.8 - 97.8 - 117.8 cm  
P 59 cm

H 6  
L 70 - 90 - 110 cm  
P 51 cm

H 15  
L 70 - 90 - 110 cm  
P 51 cm

H 2.36"  
W 26.69" - 38.50" - 46.38"  
D 23.23"

H 5.91"  
W 26.69" - 38.50" - 46.38"  
D 23.23"

H 2.36"  
W 27.56" - 35.43" - 43.31"  
D 20.08"

H 5.91"  
W 27.56" - 35.43" - 43.31"  
D 20.08"

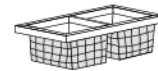
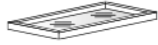
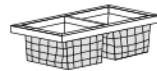

**Sacche portabiancheria**  
EN Hampers

**Telaio con vassoio**  
EN Frame with tray

**Sacche portabiancheria**  
EN Hampers

**In tessuto trapuntato**  
EN In quilted fabric

**Vassoio con fondo legno,**  
EN Tray with wooden  
bottom

**In tessuto trapuntato**  
EN In quilted fabric

H 31  
L 67.8 - 97.8 - 117.8 cm  
P 59 cm

L 67.8 - 97.8 - 117.8 cm  
P 59 cm  
W 26.69" - 38.50" - 46.38"  
D 23.23"

H 31  
L 70 - 90 - 110 cm  
P 51 cm

H 12.20"  
W 27.56" - 35.43" - 43.31"  
D 20.08"

Sacca singola su L 67.8  
EN Single hamper W 26.69"

**Vassoio con fondo vetro,**  
EN Tray with glass bottom

L 67.8 - 97.8 - 117.8 cm  
P 59 cm

Sacca singola su L 70  
EN Single hamper W 27.56"

W 26.69" - 38.50" - 46.38"  
D 23.23"

Dettaglio telaio estraibile  
con vassoio vetro,  
EN Detail of pull-out frame  
with glass tray

Dettaglio telaio  
estribile con sacca  
portabiancheria  
trapuntata,  
EN Detail of pull-out frame  
with quilted hamper



# Island

---

**Modularità,**  
**EN Modularity**

---

L 144 - 184 - 224 cm  
H 85 cm  
P 58 - 107 cm

W 56.69" - 72.44" - 88.19"  
H 33.46"  
D 22.83" - 42.13"

---

**Finiture,**  
**EN Finishes**

---

**Struttura,**  
**EN Structure**

Materico, <sup>EN</sup> Materico:  
522 Borgogna,  
518 Noce Dorato,  
520 Larice Tortora,  
501 Bon Ton,  
Perlage Terra,  
Perlage Congliolia

Laccato Opaco,  
<sup>EN</sup> Matt Lacquered

**Frontali cassetti  
Standard o frontali  
cassetti Metallo,**  
**EN Standard or metal  
Drawer fronts**

Materico, <sup>EN</sup> Materico:  
522 Borgogna,  
518 Noce Dorato,  
520 Larice Tortora,  
501 Bon Ton,  
Perlage Terra,  
Perlage Congliolia

Laccato Opaco,  
<sup>EN</sup> Matt Lacquered

Pelle Sintetica  
<sup>EN</sup> Synthetic Leather:  
Bacca, Cactus Creta,  
Elephant, Talpa

**Fondo per cassetto  
Metallo, <sup>EN</sup> Bottom for  
Metal drawer**

Vetro, <sup>EN</sup> Glass:  
Trasparente Piombo

Laccato Opaco Duna,  
<sup>EN</sup> Duna Matt Lacquered

Materico, <sup>EN</sup> Materico



## PIANCA

## Sistemi Notte EN Night Systems

### Attrezzabilità EN Accessories

Il modulo può essere completato con la teca superiore in vetro, con vassoi rivestiti nelle diverse conformazioni, e con serratura elettronica,

EN The module can be supplied with a glass top display case, with lined trays available in various configurations and with the electronic lock.

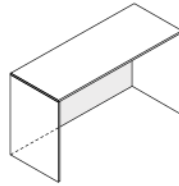

**Struttura con schienale**  
EN Structure with back

L 144 - 184 - 224 cm  
H 85 cm  
P 58 cm

W 56.69" - 72.44" - 88.19"  
H 33.46"  
D 22.83"

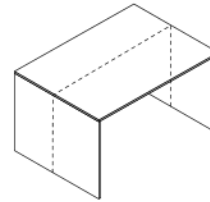

**Struttura doppia**  
EN Double structure

L 144 - 184 - 224 cm  
H 85 cm  
P 107 cm

W 56.69" - 72.44" - 88.19"  
H 33.46"  
D 42.13"

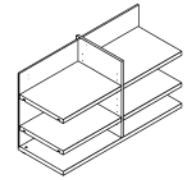

**Vano con ripiani**  
EN Shelves

L 140 - 180 - 220 cm  
H 83 cm  
P 53 cm

W 55.12" - 72.44" - 88.19"  
H 33.46"  
D 20.87"

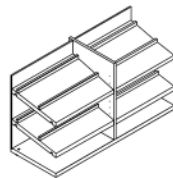

**Vano con portascarpe**  
EN Shoe shelves

L 140 - 180 - 220 cm  
H 83 cm  
P 53 cm

W 55.12" - 72.44" - 88.19"  
H 33.46"  
D 20.87"

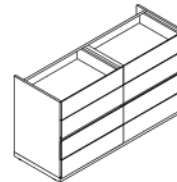

**Cassettiere Standard**  
EN Standard drawer units

**Coppia cassettiere a 4 cassetti, EN Pair of 4-drawers units**

L 140 - 180 - 220 cm  
H 83 cm  
P 53 cm

W 55.12" - 72.44" - 88.19"  
H 33.46"  
D 20.87"

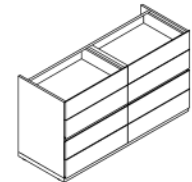

**Cassettiere Metallo**  
EN Metal drawer units

**Coppia cassettiere Metallo a 4 cassetti con fondo personalizzabile, EN Pair of Metal 4-drawers units with customizable bottom**

L 140 - 180 - 220 cm  
H 83 cm  
P 53 cm

W 55.12" - 72.44" - 88.19"  
H 33.46"  
D 20.87"



# INTERNAL ACCESSORIES

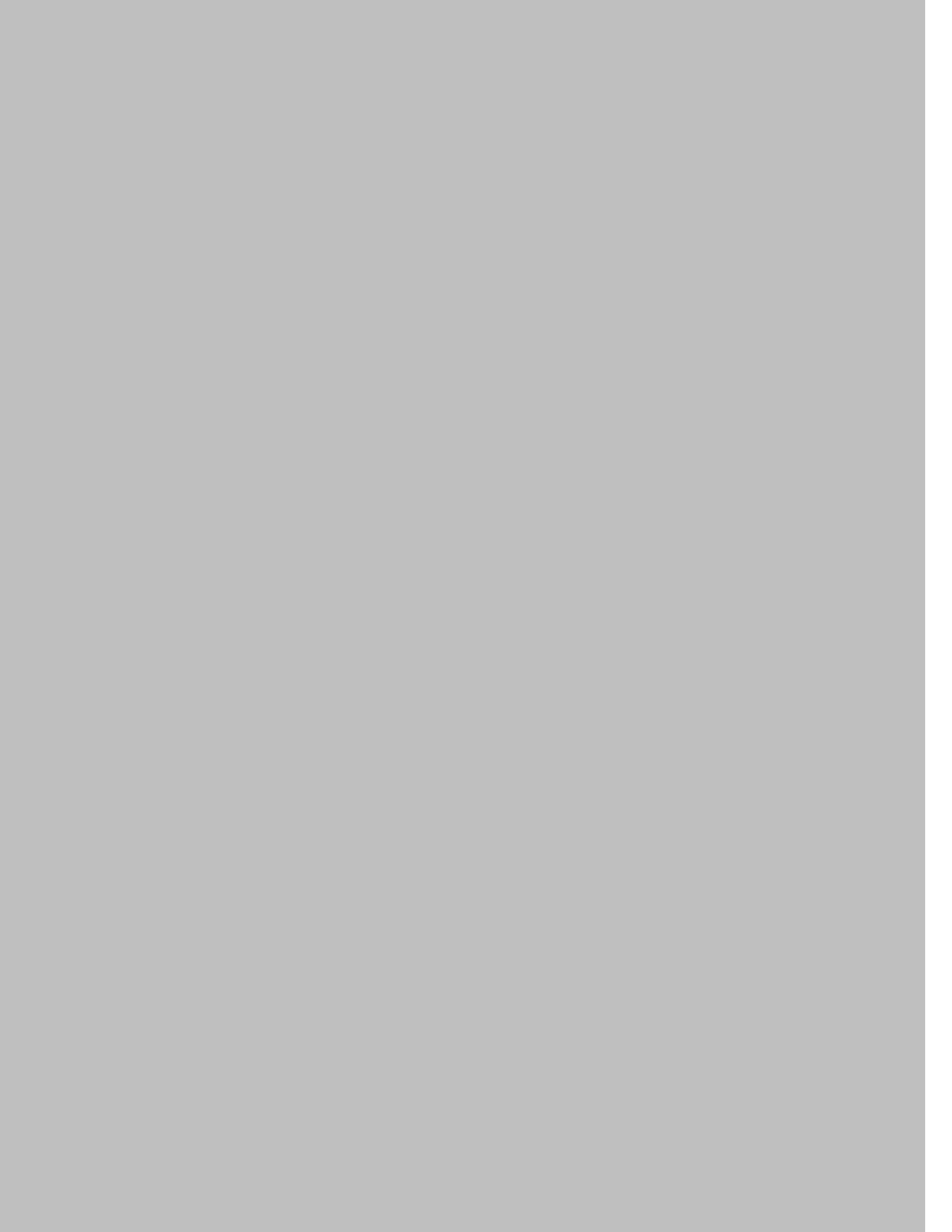







---

## Characteristics and finishes

---

<b>Wooden shelves</b>	4 cm thick, made of LIGHT engineered wood panels with a postformed synthetic veneer, which is lacquered for the lacquered versions. Finishes: Materico (Borgogna, Noce Dorato, Larice Tortora, Bon Ton, Perlage Conchiglia and Perlage Terra) or Duna matt Lacquer.
<b>Hanging rods</b>	In Manganese painted steel with ABS rod supports in the same finish as the rod. The additional rod support is made of metal alloy in the same finish as the rods.
<b>Pull-out hanging rods</b>	In Chromed metal.
<b>Shelves with Synthetic Leather insert</b>	4 cm thick, made of LIGHT engineered wood panels with a postformed synthetic veneer, which is varnished for the lacquered versions. They have an insert made up of a synthetic material panel covered in Synthetic Leather (Bacca, Cactus, Creta, Elephant and Talpa), on the top side. Finishes: Materico (Borgogna, Noce Dorato, Larice Tortora, Bon Ton, Perlage Conchiglia and Perlage Terra) or Duna matt lacquer.
<b>Framed glass shelves</b>	They are made with a frame in engineered wood with 1 cm Th tempered Piombo transparent glass and LED light recessed in the frame; they have a motion sensor to be recessed in the top of the module.
<b>LED lights</b>	Structure in metacrylate; LED strip glued on the aluminium profile.
<b>Glass shelves</b>	In transparent tempered Piombo glass 1.2 cm th.
<b>Wooden shoe rack</b>	4 cm thick, made of LIGHT engineered wood panels with a postformed synthetic veneer, which is lacquered for the lacquered versions; the shoe rack frames are in MDF covered in eco veneer. Finishes: Materico (Borgogna, Noce Dorato, Larice Tortora, Bon Ton, Perlage Conchiglia and Perlage Terra) or Duna matt lacquer.
<b>Pull-down rod</b>	Brown finished plastic spacers and mechanism.
<b>Fixed shoe rack</b>	Brown finished aluminium pipes and supports.
<b>Pull-out Tie/Belt Rack</b>	Brown finished aluminium pull-out accessories and plastic supports.
<b>Pull-out shoe rack</b>	Pull-out accessories and pipes in aluminium and supports in plastic in Brown finish; trays in polycarbonate and Fumé finish.
<b>Pull-out trousers rack</b>	Brown finished aluminium pipes and pull-out accessories and plastic supports.
<b>Pull-out knob</b>	Brown finished aluminium knob and plastic supports.
<b>Knob</b>	In Chromed metal.

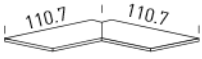
## Wooden shelves

	W	D 59 CODES	CODES D 42.3	Materico Borgogna Noce Dorato Larice Tortora Bon Ton Perlage Conchiglia Perlage Terra	Duna matt lacquered
Th 4 shelves for wardrobe modules D 39.5 on structure D 42.3 D 51.1 on structure D 59					
					
	37.8	6RL42	6RL32	43	82
	47.8	6RL43	6RL33	52	91
	57.8	6RL44	6RL34	52	91
	67.8	6RL4A	6RL3A	61	100
	77.8	6RL46	6RL36	61	100
	97.8	6RL47	6RL37	67	155
	117.8	6RL48	6RL38	85	173
	137.8	6RL4B	6RL3B	101	189
	147.8	6RL49	6RL39	101	189
	128.8	6RL41	-	93	181
	59	6RL4D	-	61	100
	46.1	6RY40	-	67	106
	46.1	6RZ40	-	67	106
	110.7	6RL45	6RL35	149	237
	128.5	6RL4L	6RL3L	85	173
	77.8	6RL4F	6RL3F	61	100
	158.5	6RL4M	6RL3M	101	189
	107.8	6RL4G	6RL3G	67	155
Shelves Th 4 with depth flush with the structure except terminal, corner and opposite corner module. D 40.3 on D 42.3 structure D 56.1/57 on D 59 structure When placing the order, please specify in which type of wardrobe they will be inserted (hinged door, sliding door, flush-sliding door, open walk-in closet)					
					
	37.8	6RL92	6RL82	43	82
	47.8	6RL93	6RL83	52	91
	57.8	6RL94	6RL84	52	91
	67.8	6RL9A	6RL8A	61	100
	77.8	6RL96	6RL86	61	100
	97.8	6RL97	6RL87	67	155
	117.8	6RL98	6RL88	85	173
	137.8	6RL9B	6RL8B	101	189
	147.8	6RL99	6RL89	101	189
	128.8	6RL91	-	93	181
Shoe shelves Th 4 (for D 42.3 structure only one shoe shelf frame is provided; minimum usable D 35 cm)					
					
	37.8	6RP42	6RP32	75	114
	47.8	6RP43	6RP33	93	132
	57.8	6RP44	6RP34	93	132
	67.8	6RP4A	6RP3A	106	145
	77.8	6RP46	6RP36	106	145
	97.8	6RP47	6RP37	118	206
	117.8	6RP48	6RP38	149	237
	137.8	6RP4B	6RP3B	180	268
	147.8	6RP49	6RP39	180	268
	128.8	6RP41	-	166	254

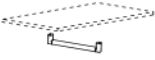

## Hanging rods

	W	D 59 CODES	Manganese	
H 7 horizontal hanging rods for wooden shelves (the tubes are transversal in the D 42.3 modules) Rods with a length of 137.8 and more, are supplied with a central support as standard.				
	37.8	6AA3A	21	
	47.8	6AA33	21	
	57.8	6AA34	21	
	67.8	6AA35	21	
	97.8	6AA37	21	
	117.8	6AA38	42	
	137.8	6AA31	42	
	147.8	6AA39	42	
for folding door closet	128.8	6AA32	28	
for opposite corner	59	6AA3D	51	
for the D 59 hinged corner (2 hanging rods)	110.7	6AA30	51	
for the D 42.3 hinged corner (2 hanging rods)	110.7	6AA3U	51	
sliding corner short side 130.7x130.7	71.7	6AA3F	21	
sliding corner long side 130.7x130.7	128.5	6AA3L	42	
sliding corner short side 160.7x160.7	101.7	6AA3G	21	
sliding corner long side 160.7x160.7	158.5	6AA3M	42	
central support		6AA40	23	
Transversal H 7 hanging rods for wooden shelves usable in D 42.3 structures in the direction of the depth (in modules wider than 97.8 cm we recommend two and in the sliding door modules three)				
	37.8	6AA3T	21	

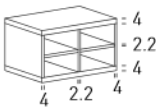
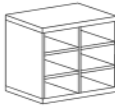
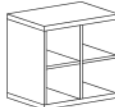

## Glass shelves

	W	D 59 CODES	CODES D 42.3	Transparent glass Piombo
Tempered glass shelves Th 1.2 D 39.5 on structure D 42.3 D 51 on structure D 59				
	37.8	6RE52	6RE32	75
	47.8	6RE53	6RE33	75
	57.8	6RE54	6RE34	83
	67.8	6RE5A	6RE3A	101
	77.8	6RE56	6RE36	101
	97.8	6RE57	6RE37	118

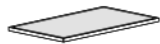

# Wooden cubbies

	W	D 59 CODES	CODES D 42.3	Materico Borgogna Noce Dorato Larice Tortora Bon Ton Perlage Conchiglia Perlage Terra	Duna matt lacquered	Synthetic leather Creta Elephant
Type A (H 42.4)						
	67.8 97.8 117.8	W63A W73A W83A	W62A W72A W82A	293 318 362	440 477 543	- - -
Type C (H 61.6)						
	67.8 97.8 117.8	W63C W73C W83C	W62C W72C W82C	380 417 467	570 626 701	- - -
Type D (H 68)						
	67.8 97.8 117.8	W63D W73D W83D	W62D W72D W82D	324 349 389	486 524 584	- - -
Boxes H 14 D 51 for cubbies D 59						
	29 44	62W12 62W14	- -	- -	- -	122 131

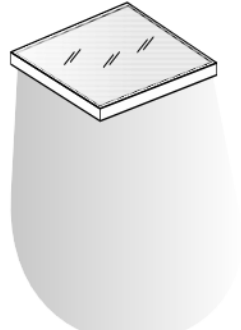
## Shelves with synthetic leather inserts and backlit glass

	W	D 59 CODES	CODES D 42.3	Materico Borgogna Noce Dorato Larice Tortora Bon Ton Perlage Conchiglia Perlage Terra	Duna matt lacquered	
<p>Wooden linear shelves Th 4 with insert in Synthetic Leather (Bacca, Cactus, Creta, Elephant and Talpa) The hanging rods must be the same width as the shelf, therefore on shelves for D 42.3 wardrobes, the transversal hanging rod cannot be mounted.</p>						
		37.8	6RM42	6RM32	226	265
		47.8	6RM43	6RM33	238	277
		57.8	6RM44	6RM34	249	288
		67.8	6RM4A	6RM3A	251	290
		77.8	6RM46	6RM36	253	292
		97.8	6RM47	6RM37	264	352
		117.8	6RM48	6RM38	330	418
		137.8	6RM4B	6RM3B	350	438
		147.8	6RM49	6RM39	350	438
		128.8	6RM41	-	340	428
		59	6RM4D	-	251	290
<p>Wooden linear shelves Th 4 with insert in Synthetic Leather (Bacca, Cactus, Creta, Elephant and Talpa) with depth flush with the structure (except for terminal, corner and opposite corner modules) When placing the order, specify in which type of wardrobe they will be inserted (hinged door, sliding door, flush-sliding door, open walk-in closet)</p>						
		37.8	6RM92	6RM82	226	265
		47.8	6RM93	6RM83	238	277
		57.8	6RM94	6RM84	249	288
		67.8	6RM9A	6RM8A	251	290
		77.8	6RM96	6RM86	253	292
		97.8	6RM97	6RM87	264	352
		117.8	6RM98	6RM88	330	418
		137.8	6RM9B	6RM8B	350	438
		147.8	6RM99	6RM89	352	440
		128.8	6RM91	-	340	428
<p>Piombo transparent glass shelves with D59 frame with 3000 K° LED light built in the frame and motion sensor inserted in the top. <b>When placing your order, please mark in which compartment the shelf with light has to be inserted because it cannot be added in a second time.</b> Hanging rods cannot be used.</p>						
		47.8	6RF53	-	344	383
		57.8	6RF54	-	344	383
		67.8	6RF5A	-	344	383
		97.8	6RF57	-	375	463

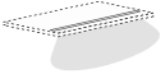

## LED Lights

	W	CODES		Materico Borgogna Noce Dorato Larice Tortora Bon Ton Perlage Conchiglia Perlage Terra	Duna matt lacquered
<p>3000 K horizontal LED lights recessed in the shelves and top, fitted with a motion sensor that turns the lights on.</p> <p><b>When placing your order,</b></p> <ul style="list-style-type: none"> <li>· you must indicate in which compartment you would like the light to be inserted as it cannot be added at a later time</li> <li>· it is possible to request the light without the sensor (connected and switched on by the customer)</li> </ul>					
		<b>47.8 62AXP3</b>	215	-	-
		<b>57.8 62AXP4</b>	222	-	-
		<b>67.8 62AXPA</b>	227	-	-
		<b>97.8 62AXP7</b>	244	-	-
		<b>117.8 62AXP8</b>	262	-	-
		<b>137.8 62AXPB</b>	274	-	-
		<b>147.8 62AXP9</b>	281	-	-
<p>for hinged door corner</p> <p>sliding corner short side 130.7x130.7</p> <p>sliding corner long side 130.7x130.7</p> <p>sliding corner short side 160.7x160.7</p> <p>sliding corner long side 160.7x160.7</p>		<b>62AXP5</b>	347	-	-
		<b>62AXPF</b>	216	-	-
		<b>62AXPL</b>	216	-	-
		<b>62AXPG</b>	226	-	-
		<b>62AXPM</b>	226	-	-
<p>for folding door closet</p>	<b>128.8</b>	<b>62AXP1</b>	274	-	-
<p>3000 K° verticl LED lights built in the side/partition with motion sensor</p> <p><b>When placing your order</b></p> <ul style="list-style-type: none"> <li>· mark in which side/partition the light has to be applied to because it cannot be added in a second time</li> <li>· it is possible to request the light without the sensor (connected and switched on by the customer)</li> </ul> <p>It is not possible to apply the light to th.1,9 finishing sides for hinged doors and on modules with open elements.</p>	<b>H</b>				
		<b>238.5 6AY07 D/S</b>	332	-	-
		<b>257.7 6AY08 D/S</b>	332	-	-
		<b>289.7 6AY09 D/S</b>	357	-	-

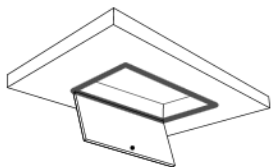
Inspection hatch L 35 D 20 with Brown frame  
When placing the order, indicate the mod. in which it is to be inserted, specifying whether in the top or in the base.

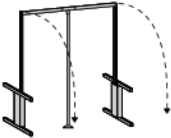

# Accessories

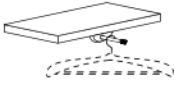
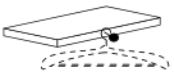
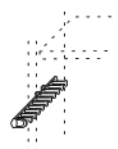
		Brown	Cromo
		<b>W CODES</b>	
<p>Pull-down rods (10 Kg weight capacity)</p> 		<p>67.8 62TX5 175</p> <p>97.8 62TX7 175</p> <p>117.8 62TX8 175</p>	-
<p>Pull-out hanging rod 36 D for wood shelves</p> 		<p>62TW0 -</p>	35
<p>Pull-out knobs for wooden shelves Cannot be mounted on shelves flush to the front of the closet structure. The external pull-out knob cannot be applied on shelves with light.</p>  <p style="text-align: right;">external</p>  <p style="text-align: right;">recessed inside the shelf</p>		<p>62TYC 25</p> <p>62TYD -</p>	-
<p>Belt holder/tie holder D 50 to be fixed to the side/partition</p> 			

# Accessories

Brown

Synthetic leather  
Elephant

W D 59  
CODES

Pull-out tie rack D 36.5 L 11  
with 20 brushed metal pins  
covered in Elephant synthetic leather

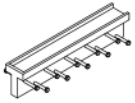

62TZ2

-

206

Fixed shoe rack D 22

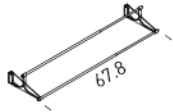

67.8 62TR4

39

-

Basic pull-out shoe rack D 50  
(cannot be used on open closet with frame)

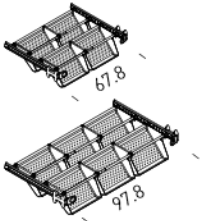

67.8 62TS5

238

-

97.8 62TS7

290

-

Basic pull-out trousers rack D 50  
(cannot be used on open closet with frame)

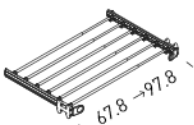



## Internal mirrors

Mirror  
Argento

H CODES

Fixed mirror with anodised black mirror-holder  
to be applied to the back of hinged/cardine hinged door  
(it cannot be used if the wardrobe shelves are flush with  
the wardrobe structure)

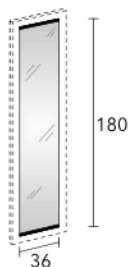

180 6AXS2

149

Swiveling mirror  
to be attached to the door  
(the opening direction can be decided during assembly)

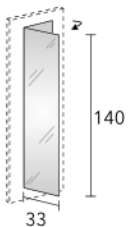

140 6AXS4

175

Pull-out and swiveling mirror  
to be attached to the side of sliding and flush sliding door  
wardrobes

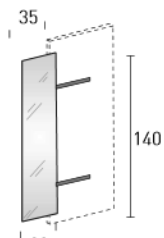

# Partitions

## Partitions fixed on the base

2.2. cm Th, they divide the wardrobe internal space. Marks for positioning adjustable shelves are positioned at a distance of 6.4 cm from sides and partitions. The type of wardrobe in which they are to be inserted must be specified. With the exception of the full height internal partitions, they must always be completed with a closing top shelf.

## T partitions for drawer units

They are needed to use a drawer unit that is smaller than the module. Made up of a 2.2 cm Th partition without marks for shelf support, a 4 cm Th top shelf and any possible 4 cm Th shelves for the side space. The T can accommodate drawer units shorter than the partition, creating a storage space (type A) or drawer units having the same height as the vertical partition itself (type B). In this case the shelf for drawer unit is not necessary, **therefore, please deduct the price of the finishing shelf for drawer unit from your calculation.**

solution A



solution B

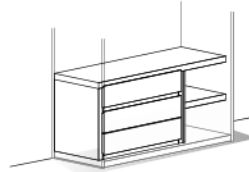

example of possible solutions

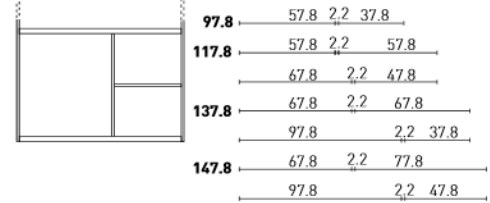

Full-length partitions for frameless hinged, cardine hinged and walk-in wardrobe modules



for wardrobes H 289.7  
for wardrobes H 257.7  
for wardrobes H 238.5

H	D 59 CODES	CODES D 42.3	Materico Borgogna Noce Dorato Larice Tortona Bon Ton Perlage Conchiglia Perlage Terra	Duna matt lacquered
282	62DZ92	62DZ93	185	365
250	62DZ82	62DZ83	168	348
230	62DZ72	62DZ73	168	348
Full height partitions for sliding door modules, flush sliding door modules and walk-in closets with frames				
for wardrobes H 289.7				
270	62DY92	62DY93	185	365
for wardrobes H 257.7				
238	62DY82	62DY83	168	348
for wardrobes H 238.5				
219	62DY72	62DY73	168	348
Base partitions for frameless hinged, cardine hinged and walk-in wardrobe modules				
238	62DZ22	62DZ62	155	335
206	62DZ19	62DZ59	140	320
174	62DZ16	62DZ56	124	304
142	62DZ13	62DZ53	107	195
110	62DZ10	62DZ50	93	181
78	62DZ06	62DZ46	75	114
46	62DZ03	62DZ43	61	100
Partitions fixed on the base for sliding door, flush sliding door modules and walk-in closet modules with frames				
233	62DY22	62DY62	155	335
201	62DY19	62DY59	140	320
169	62DY16	62DY56	124	304
137	62DY13	62DY53	107	195
105	62DY10	62DY50	93	181
73	62DY06	62DY46	75	114

Base partitions for frameless hinged, cardine hinged and walk-in wardrobe modules

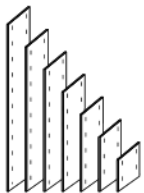

Partitions fixed on the base for sliding door, flush sliding door modules and walk-in closet modules with frames

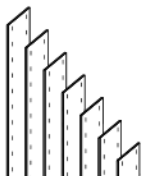

## Floor sitting T partitions for drawer units

For H 43 2-drawer units

### D 42.3 also available

[The code is different by one character.

E.g. TJ272 becomes TQ272]

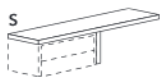

modules 57.8 / 37.8  
modules 57.8 / 57.8  
modules 67.8 / 47.8  
modules 67.8 / 58.8  
modules 67.8 / 67.8  
modules 97.8 / 37.8  
modules 67.8 / 77.8  
modules 97.8 / 47.8

For H 49 2-drawer units



modules 57.8 / 37.8  
modules 57.8 / 57.8  
modules 67.8 / 47.8  
modules 67.8 / 58.8  
modules 67.8 / 67.8  
modules 97.8 / 37.8  
modules 67.8 / 77.8  
modules 97.8 / 47.8

For H 64 3-drawer units

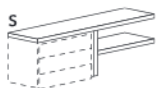

modules 57.8 / 37.8  
modules 57.8 / 57.8  
modules 67.8 / 47.8  
modules 67.8 / 58.8  
modules 67.8 / 67.8  
modules 97.8 / 37.8  
modules 67.8 / 77.8  
modules 97.8 / 47.8

For H 71 3-drawer units



modules 57.8 / 37.8  
modules 57.8 / 57.8  
modules 67.8 / 47.8  
modules 67.8 / 58.8  
modules 67.8 / 67.8  
modules 97.8 / 37.8  
modules 67.8 / 77.8  
modules 97.8 / 47.8

W CODES  
D 59

Wooden shelves

Shelves Synth. Leather Insert

Materico

Duna matt  
lacquered

Materico

Duna matt  
lacquered

97.8	TJ272 D/S	127	253	324	450
117.8	TJ281 D/S	146	272	390	516
117.8	TJ282 D/S	146	272	390	516
128.8	TJ210 D/S	153	279	401	527
137.8	TJ211 D/S	161	287	410	536
137.8	TJ212 D/S	161	287	410	536
147.8	TJ292 D/S	161	287	410	536
147.8	TJ293 D/S	161	287	410	536

97.8	TJ772 D/S	127	253	324	450
117.8	TJ781 D/S	146	272	390	516
117.8	TJ782 D/S	146	272	390	516
128.8	TJ710 D/S	153	279	401	527
137.8	TJ711 D/S	161	287	410	536
137.8	TJ712 D/S	161	287	410	536
147.8	TJ792 D/S	161	287	410	536
147.8	TJ793 D/S	161	287	410	536

97.8	TJ372 D/S	175	340	555	720
117.8	TJ381 D/S	203	369	645	810
117.8	TJ382 D/S	203	369	633	798
128.8	TJ310 D/S	219	384	657	822
137.8	TJ311 D/S	227	392	666	831
137.8	TJ312 D/S	209	375	641	806
147.8	TJ392 D/S	227	392	668	834
147.8	TJ393 D/S	219	384	653	818

97.8	TJ872 D/S	175	340	555	720
117.8	TJ881 D/S	203	369	645	810
117.8	TJ882 D/S	203	369	633	798
128.8	TJ810 D/S	219	384	657	822
137.8	TJ811 D/S	227	392	666	831
137.8	TJ812 D/S	209	375	641	806
147.8	TJ892 D/S	227	392	668	834
147.8	TJ893 D/S	219	384	653	818

## Floor sitting T partitions for drawer units

For H 81 4-drawer units

### D 42.3 also available

[The code is different by one character.

E.g. TJ472 becomes TQ472]

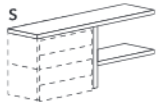

modules 57.8 / 37.8  
modules 57.8 / 57.8  
modules 67.8 / 47.8  
modules 67.8 / 58.8  
modules 67.8 / 67.8  
modules 97.8 / 37.8  
modules 67.8 / 77.8  
modules 97.8 / 47.8

W	CODES D 59	Wooden shelves		Shelves Synth. Leather Insert	
		Materico	Duna matt lacquered	Materico	Duna matt lacquered
	<b>97.8</b> TJ472 D/S	183	397	563	777
	<b>117.8</b> TJ481 D/S	212	425	653	867
	<b>117.8</b> TJ482 D/S	212	425	641	855
	<b>128.8</b> TJ410 D/S	227	441	665	878
	<b>137.8</b> TJ411 D/S	235	449	674	888
	<b>137.8</b> TJ412 D/S	218	431	649	863
	<b>147.8</b> TJ492 D/S	235	449	677	890
	<b>147.8</b> TJ493 D/S	227	441	661	875

For H 88 4-drawer units

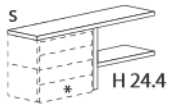

modules 57.8 / 37.8  
modules 57.8 / 57.8  
modules 67.8 / 47.8  
modules 67.8 / 58.8  
modules 67.8 / 67.8  
modules 97.8 / 37.8  
modules 67.8 / 77.8  
modules 97.8 / 47.8

	<b>97.8</b> TJ972 D/S	183	397	563	777
	<b>117.8</b> TJ981 D/S	212	425	653	867
	<b>117.8</b> TJ982 D/S	212	425	641	855
	<b>128.8</b> TJ910 D/S	227	441	665	878
	<b>137.8</b> TJ911 D/S	235	449	674	888
	<b>137.8</b> TJ912 D/S	218	431	649	863
	<b>147.8</b> TJ992 D/S	235	449	677	890
	<b>147.8</b> TJ993 D/S	227	441	661	875

For H103 5-drawer units

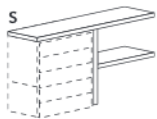

modules 57.8 / 37.8  
modules 57.8 / 57.8  
modules 67.8 / 47.8  
modules 67.8 / 58.8  
modules 67.8 / 67.8  
modules 97.8 / 37.8  
modules 67.8 / 77.8  
modules 97.8 / 47.8

	<b>97.8</b> TJ572 D/S	194	408	574	788
	<b>117.8</b> TJ581 D/S	222	436	664	877
	<b>117.8</b> TJ582 D/S	222	436	652	865
	<b>128.8</b> TJ510 D/S	238	451	675	889
	<b>137.8</b> TJ511 D/S	246	460	685	898
	<b>137.8</b> TJ512 D/S	228	442	660	874
	<b>147.8</b> TJ592 D/S	246	460	687	901
	<b>147.8</b> TJ593 D/S	238	451	672	885

For H 120 6-drawer units

### D 42.3 also available

[The code is different by one character.

E.g. TJ672 becomes TQ672]

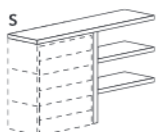

modules 57.8 / 37.8  
modules 57.8 / 57.8  
modules 67.8 / 47.8  
modules 67.8 / 58.8  
modules 67.8 / 67.8  
modules 97.8 / 37.8  
modules 67.8 / 77.8  
modules 97.8 / 47.8

	<b>97.8</b> TJ672 D/S	244	496	806	1.059
	<b>117.8</b> TJ681 D/S	281	534	920	1.172
	<b>117.8</b> TJ682 D/S	281	534	896	1.149
	<b>128.8</b> TJ610 D/S	305	557	933	1.185
	<b>137.8</b> TJ611 D/S	313	566	942	1.195
	<b>137.8</b> TJ612 D/S	278	530	893	1.145
	<b>147.8</b> TJ692 D/S	313	566	947	1.199
	<b>147.8</b> TJ693 D/S	297	549	911	1.169

## Standard drawer units characteristics

### Characteristics

The structure and fronts are made of particle board panels coated and edged in synthetic finish. All drawers have an invisible guide with a galvanized metal structure, sliding rollers, automatic closing recall, anti-release stop, vertical adjust and soft closing. Guides are provided as a standard with partial extension; **upon request and with a surcharge**, guides with full extension can be supplied.

### Structure

Whole single, double or triple drawer units are available. By stacking the different elements you can obtain combinations of four, five or six drawers. The drawer units are already equipped with a 4 cm Th finishing top.

#### Finishes:

- Materico (Borgogna, Noce Dorato, Larice Tortora, Bon Ton, Perlage Conchiglia e Perlage Terra)
- Duna matt lacquered.

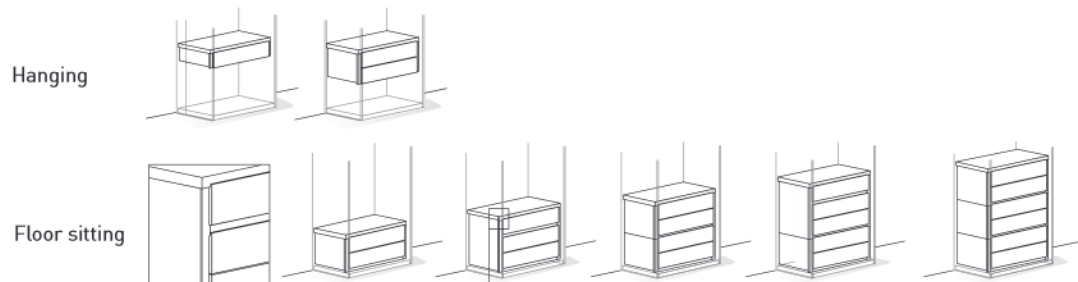

### Drawers

They have 1.8 cm Th fronts in particle board panel, 2 cm Th fronts with inserts in synthetic leather or 2.2 cm Th fronts with glass/mirror glued directly on the particle board panel without any frame. They have a groove for opening at the top and bottom ends of the pair of drawers. In case of one, three or five drawer units the groove is always placed on the top side of the drawer front.

**The difference in thickness of the fronts does not allow drawer units with mixed wooden/synthetic leather/glass/mirror fronts to be created. We also do not recommend combinations.**

The drawer units, floor sitting or wall mounted, have H 18 cm fronts and H 14 cm drawer structure, or H 24,4 cm fronts and H 20 cm drawer structure for the floor sitting version. As standard, drawer frames made with particle board panels with a grey synthetic cover are installed.

#### Finishes:

- Materico (Borgogna, Noce Dorato, Larice Tortora, Bon Ton, Perlage Conchiglia e Perlage Terra)
- Duna matt lacquered
- Matt or glossy glass (Bianco, Piombo, Roccia and Seta as standard)
- Metallizzato glass and mirror (Argento, Bronzo and Piombo)
- Matt and glossy marble glass (Sahara, Calacatta, Amani)
- Synthetic leather (Bacca, Cactus, Creta, Elephant and Talpa).



**Floor sitting or suspended**  
Drawer fronts  
H 18  
H 18

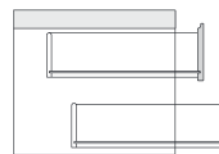

**Floor sitting**  
Drawer fronts  
H 18  
H 24.4

### Possible equipment options

**Upon request**, the bottom drawer of D 59 hanging drawer units, can be equipped with a H 5 cm metal frame painted Canna di Fucile, to be paired with one the following accessories: trouser rack, hampers or shoe rack.

**Upon request and with a surcharge**, on the top drawer of each drawer unit it is possible to install an electronic lock (please see ELECTRONIC LOCK on internal drawer units)

### Possible solutions

The drawer units **are not free standing**. They can be floor sitting or hanging, suspended between two sides or partitions; with T-shaped elements or with internal partitions that create top spaces or at equal height.

**When placing the order, please always indicate in which module the internal drawer units will be inserted.**

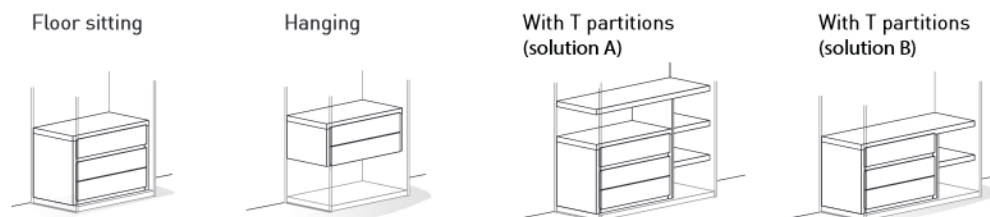

## Standard drawer units

### Extension

Partial extension included in the price  
Full extension: each drawer LSX6 + €28

### Lock

Electronic lock: each + €255

**Drawer units include a 4 cm Th finishing shelf.**

W CODES  
D 59

\*N Wooden  
\*T Glass  
\*P Synth.  
Leather

### Materico Structure

### Duna matt lacquered structure

Front  
Materico

Front  
Lacq.glass  
Metall.glass  
Mirror  
Synth.leather

Front  
Marble glass

Fronts  
Duna matt  
lacq.

Front  
Lacq.glass  
Metall.glass  
Mirror  
Synth.leather

Front  
Marble glass

### H 22 1-drawer unit

hanging



<b>57.8</b>	<b>TI114*</b>	149	186	206	236	272	292
<b>67.8</b>	<b>TI115*</b>	157	194	214	245	280	300
<b>97.8</b>	<b>TI117*</b>	185	219	242	331	360	383
<b>117.8</b>	<b>TI118*</b>	219	264	291	373	413	441
<b>137.8</b>	<b>TI111*</b>	253	306	338	417	465	496
<b>147.8</b>	<b>TI119*</b>	253	306	338	417	465	496

### H 38 2-drawer unit

**Also available for D 42.3 structure**

[The code is different by one character.  
E.g. TI214N becomes TD214N]

hanging



<b>57.8</b>	<b>TI214*</b>	200	274	308	313	391	424
<b>67.8</b>	<b>TI215*</b>	208	283	317	321	399	432
<b>97.8</b>	<b>TI217*</b>	257	326	365	439	504	543
<b>117.8</b>	<b>TI218*</b>	307	396	443	506	593	639
<b>137.8</b>	<b>TI211*</b>	360	469	524	578	686	740
<b>147.8</b>	<b>TI219*</b>	360	469	524	578	686	740

### H 43 2-drawer unit

**Also available for D 42.3 structure**

[The code is different by one character.  
E.g. TH214N becomes TP214N]

floor sitting



<b>57.8</b>	<b>TH214*</b>	222	294	331	346	418	455
<b>67.8</b>	<b>TH215*</b>	231	303	339	354	426	463
<b>97.8</b>	<b>TH217*</b>	278	347	390	471	534	575
<b>117.8</b>	<b>TH218*</b>	327	418	469	536	622	672
<b>137.8</b>	<b>TH211*</b>	382	490	549	609	714	772
<b>147.8</b>	<b>TH219*</b>	382	490	549	609	714	772

### H 49 2-drawer unit

floor sitting

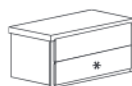

H 24.4

<b>57.8</b>	<b>TH254*</b>	229	308	347	357	437	476
<b>67.8</b>	<b>TH255*</b>	238	317	356	365	445	484
<b>97.8</b>	<b>TH257*</b>	288	364	409	487	556	600
<b>117.8</b>	<b>TH258*</b>	342	439	493	557	651	704
<b>137.8</b>	<b>TH251*</b>	398	517	580	634	751	814
<b>147.8</b>	<b>TH259*</b>	398	517	580	634	751	814

### H 64 3-drawer unit

floor sitting



<b>57.8</b>	<b>TH314*</b>	321	431	489	495	603	660
<b>67.8</b>	<b>TH315*</b>	330	439	497	503	612	668
<b>97.8</b>	<b>TH317*</b>	397	503	569	649	744	809
<b>117.8</b>	<b>TH318*</b>	464	602	680	742	871	948
<b>137.8</b>	<b>TH311*</b>	537	700	791	843	998	1.087
<b>147.8</b>	<b>TH319*</b>	537	700	791	843	998	1.087

## Standard drawer units

### Extension

Partial extension included in the price  
Full extension: each drawer LSX6 + €28

### Lock

Electronic lock: each + €255

**Drawer units include a 4 cm Th finishing shelf.**

### W CODES D 59

\*N Wooden  
\*T Glass  
\*P Synth.  
Leather

### Materico Structure

### Duna matt lacquered structure

Front  
Materico

Front  
Lacq.glass  
Metall.glass  
Mirror  
Synth.leather

Front  
Marble glass

Fronts  
Duna matt  
lacq.

Front  
Lacq.glass  
Metall.glass  
Mirror  
Synth.leather

Front  
Marble glass

### H 71 3-drawer unit

floor sitting

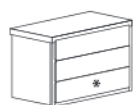

H24.4

<b>57.8</b>	<b>TH354*</b>	329	445	504	506	622	681
<b>67.8</b>	<b>TH355*</b>	337	454	513	514	631	690
<b>97.8</b>	<b>TH357*</b>	408	520	588	666	766	834
<b>117.8</b>	<b>TH358*</b>	478	624	705	763	900	980
<b>137.8</b>	<b>TH351*</b>	554	727	822	868	1.034	1.129
<b>147.8</b>	<b>TH359*</b>	554	727	822	868	1.034	1.129

### H 81 4-drawer unit

**Also available for D 42.3 structure**

[The code is different by one character.

E.g. TH414N becomes TP414N]

floor sitting



<b>57.8</b>	<b>TH414*</b>	392	536	609	601	745	818
<b>67.8</b>	<b>TH415*</b>	401	544	618	609	753	826
<b>97.8</b>	<b>TH417*</b>	489	628	713	789	914	996
<b>117.8</b>	<b>TH418*</b>	569	751	852	900	1.072	1.171
<b>137.8</b>	<b>TH411*</b>	662	880	998	1.031	1.241	1.356
<b>147.8</b>	<b>TH419*</b>	662	880	998	1.031	1.241	1.356

### H 88 4-drawer unit

floor sitting



H24.4

<b>57.8</b>	<b>TH454*</b>	399	550	626	612	764	839
<b>67.8</b>	<b>TH455*</b>	408	559	634	620	772	848
<b>97.8</b>	<b>TH457*</b>	500	645	732	804	936	1.021
<b>117.8</b>	<b>TH458*</b>	583	772	876	921	1.203	1.100
<b>137.8</b>	<b>TH451*</b>	679	907	1.028	1.055	1.277	1.398
<b>147.8</b>	<b>TH459*</b>	679	907	1.028	1.055	1.277	1.398

### H 103 5-drawer unit

floor sitting



<b>57.8</b>	<b>TH514*</b>	491	673	767	750	930	1.024
<b>67.8</b>	<b>TH515*</b>	500	681	776	758	939	1.032
<b>97.8</b>	<b>TH517*</b>	608	784	893	967	1.124	1.230
<b>117.8</b>	<b>TH518*</b>	706	935	1.064	1.105	1.321	1.447
<b>137.8</b>	<b>TH511*</b>	818	1.090	1.239	1.264	1.524	1.671
<b>147.8</b>	<b>TH519*</b>	818	1.090	1.239	1.264	1.524	1.671

### H 120 6-drawer unit

**Also available for D 42.3 structure**

[The code is different by one character.

E.g. TH614N becomes TP614N]

floor sitting



<b>57.8</b>	<b>TH614*</b>	562	778	888	856	1.072	1.182
<b>67.8</b>	<b>TH615*</b>	570	786	896	864	1.080	1.190
<b>97.8</b>	<b>TH617*</b>	700	909	1.037	1.106	1.294	1.418
<b>117.8</b>	<b>TH618*</b>	811	1.084	1.236	1.263	1.522	1.670
<b>137.8</b>	<b>TH611*</b>	943	1.269	1.446	1.452	1.767	1.940
<b>147.8</b>	<b>TH619*</b>	943	1.269	1.446	1.452	1.767	1.940

## Metal drawer units characteristics and finishes

### Characteristics

The structure and fronts are made of particle board panels coated and edged in synthetic finish. All drawers have an invisible guide with a galvanized metal structure, sliding rollers, automatic closing recall, anti-release stop, vertical adjust and soft closing. Guides are provided as a standard with total extension.

### Structure

Whole single, double or triple drawer units are available. By stacking the different elements you can obtain combinations of four, five or six drawers. The drawer units are already equipped with a 4 cm Th finishing top.

#### Finishes:

- Materico (Borgogna, Noce Dorato, Larice Tortora, Bon Ton, Perlage Conchiglia e Perlage Terra)
- Duna matt lacquered.

### Hanging

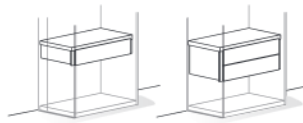

### Floor sitting

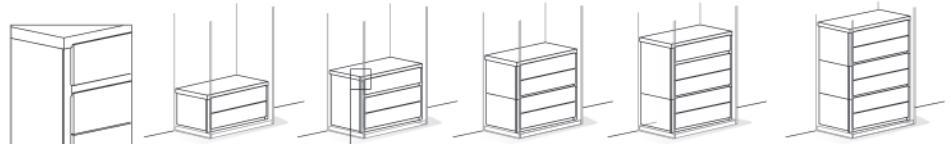

### Drawers with metal drawer frame

They have 1.8 cm Th fronts in particle board panel, 2 cm Th fronts with inserts in synthetic leather or 2.2 cm Th fronts with glass/mirror glued directly on the particle board panel without any frame. They have a groove for opening at the top and bottom ends of the pair of drawers. In case of one, three or five drawer units the groove is always placed on the top side of the drawer front.

**The difference in thickness of the fronts does not allow drawer units with mixed wooden/synthetic leather/glass/mirror fronts to be created. We also do not recommend combinations.** The drawer units, floor sitting or wall mounted, have H 18 cm fronts, or H 24,4 cm fronts for the floor sitting version. H 12,8 cm Canna di Fucile drawer frames are provided as standard, with the drawer bottom colour matching the drawer unit.

#### Finishes:

- Materico (Borgogna, Noce Dorato, Larice Tortora, Bon Ton, Perlage Conchiglia, Perlage Terra)
- Duna matt lacquered
- Matt or glossy glass (Bianco, Piombo, Roccia and Seta as standard)
- Metallizzato glass and mirror (Argento, Bronzo, Piombo)
- Matt and glossy marble glass (Sahara, Calacatta, Amani)
- Synthetic leather (Bacca, Cactus, Creta, Elephant, Talpa).



**Floor sitting or suspended**  
Drawer fronts  
H 18  
H 18



**Floor sitting**  
Drawer fronts  
H 18  
H 24.4

### Miro drawer units with metal drawer frame and glass front

They have H 18 Th 1,8 glass fronts and Canna di Fucile aluminium frame, which has a groove for opening at the top and bottom ends of the pair of drawers. The H 12,8 cm metal drawer frame is always in Canna di Fucile finish with drawer bottom colour-matching the drawer unit's structure.

#### Finishes:

- Transparent glass (Argento, Bronzo and Piombo)
- Riflettente glass (Argento, Bronzo and Piombo)
- Trama glass (Argento, Bronzo and Piombo)

### Personalisations

**Upon request**, the drawer bottom of each individual drawer with metal drawer frames, can be customised with a different colour than the standard one; Materico for drawer units with Materico structure and Duna matt lacquered for drawer units with structure in the same finish. **With a surcharge** the following finishes are also available: Duna matt lacquered, where not standard already, or Piombo transparent glass.

### Possible equipment options

**Upon request**, the bottom drawer of D 59 hanging drawer units, can be equipped with a H 5 cm metal frame painted Canna di Fucile, to be paired with one the following accessories: trouser rack, hampers or shoe rack. **Upon request and with a surcharge**, on the top drawer of each drawer unit it is possible to install an electronic lock, except for MIRO drawers (please see ELECTRONIC LOCK on internal drawer units)

### Possible solutions

The drawer units **are not free standing**. They can be floor sitting or hanging, suspended between two sides or partitions; with T-shaped elements or with internal partitions that create top spaces or at equal height.

**When placing the order, please always indicate in which module the internal drawer units will be inserted.**



## Metal drawer units

### Extension

Full extension included in the price

### Lock

Electronic lock: each + €255

### Drawer bottom

Colour matching the structure as standard

Matt lacquered drawer bottom: each

LSGM5 + €35

Transp. Piombo glass drawer bottom: each

LSGM7 + €35

**Drawer units include a 4 cm Th finishing shelf.**

### W CODES D 59

\*N Wooden

\*T Glass

\*P Synth.  
Leather

### Materico Structure

### Duna matt lacquered structure

H 22 1-drawer unit

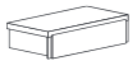

hanging

**67.8** TI115\*M  
**97.8** TI117\*M  
**117.8** TI118\*M

426  
480  
533

463  
514  
578

483  
537  
605

514  
626  
687

549  
655  
727

569  
678  
755

H 38 2-drawer unit

**Also available for D 42.3 structure**

[The code is different by one character.

E.g. TI215NM becomes TD215NM]



hanging

**67.8** TI215\*M  
**97.8** TI217\*M  
**117.8** TI218\*M

746  
847  
935

821  
916  
1.024

855  
955  
1.071

860  
1.029  
1.133

937  
1.094  
1.221

970  
1.133  
1.267

H 43 2-drawer unit

**Also available for D 42.3 structure**

[The code is different by one character.

E.g. TH215NM becomes TP215NM]

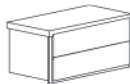

floor sitting

**67.8** TH215\*M  
**97.8** TH217\*M  
**117.8** TH218\*M

769  
868  
955

841  
937  
1.046

877  
980  
1.097

893  
1.061  
1.164

965  
1.124  
1.250

1.001  
1.165  
1.300

H 49 2-drawer unit



H 24.4

floor sitting

**67.8** TH255\*M  
**97.8** TH257\*M  
**117.8** TH258\*M

776  
878  
969

855  
954  
1.067

894  
999  
1.120

903  
1.077  
1.185

983  
1.146  
1.278

1.022  
1.190  
1.332

H 64 3-drawer unit

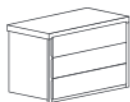

floor sitting

**67.8** TH315\*M  
**97.8** TH317\*M  
**117.8** TH318\*M

1.137  
1.282  
1.406

1.247  
1.388  
1.544

1.304  
1.454  
1.622

1.310  
1.534  
1.683

1.419  
1.629  
1.813

1.475  
1.694  
1.890

## Metal drawer units

### Extension

Full extension included in the price

### Lock

Electronic lock: each + €255

### Drawer bottom

Colour matching the structure as standard

Matt lacquered drawer bottom: each

LSGM5 + €35

Transp. Piombo glass drawer bottom: each

LSGM7 + €35

**Drawer units include a 4 cm Th finishing shelf.**

H 71 3-drawer unit

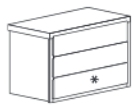

floor sitting

**67.8** TH355\*M  
**97.8** TH357\*M  
**117.8** TH358\*M

1.144  
1.293  
1.420

1.261  
1.405  
1.565

1.320  
1.473  
1.647

1.321  
1.551  
1.704

1.438  
1.651  
1.841

1.497  
1.719  
1.922

H 81 4-drawer unit

**Also available for D 42.3 structure**

[The code is different by one character.

E.g. TH415NM becomes TP415NM]



floor sitting

**67.8** TH415\*M  
**97.8** TH417\*M  
**117.8** TH418\*M

1.477  
1.669  
1.825

1.621  
1.808  
2.006

1.694  
1.893  
2.108

1.686  
1.969  
2.155

1.829  
2.094  
2.327

1.903  
2.176  
2.427

H 88 4-drawer unit



floor sitting

**67.8** TH455\*M  
**97.8** TH457\*M  
**117.8** TH458\*M

1.484  
1.680  
1.839

1.635  
1.825  
2.028

1.710  
1.912  
2.132

1.696  
1.984  
2.176

1.848  
2.116  
2.356

1.924  
2.201  
2.458

H 103 5-drawer unit



floor sitting

**67.8** TH515\*M  
**97.8** TH517\*M  
**117.8** TH518\*M

1.845  
2.083  
2.276

2.027  
2.259  
2.504

2.121  
2.368  
2.633

2.103  
2.442  
2.674

2.284  
2.599  
2.890

2.377  
2.705  
3.017

H 120 6-drawer unit

**Also available for D 42.3 structure**

[The code is different by one character.

E.g. TH615NM becomes TP615NM]



floor sitting

**67.8** TH615\*M  
**97.8** TH617\*M  
**117.8** TH618\*M

2.185  
2.470  
2.694

2.401  
2.679  
2.967

2.510  
2.807  
3.119

2.478  
2.876  
3.146

2.694  
3.064  
3.405

2.804  
3.188  
3.553

W CODES  
D 59

\*N Wooden  
\*T Glass  
\*P Synth.  
Leather

Materico Structure

Duna matt lacquered structure

Front  
Materico

Front  
Lacq.glass  
Metall.glass  
Mirror  
Synth.leather

Front  
Marble glass

Fronts  
Duna matt  
lacq.

Front  
Lacq.glass  
Metall.glass  
Mirror  
Synth.leather

Front  
Marble glass

## Miro metal drawer units

### Extension

Full extension included in the price

### Drawer bottom

Colour matching the structure as standard

Matt lacquered drawer bottom: each

LSGM5 + €35

Transp. Piombo glass drawer bottom: each

LSGM7 + €35

**Drawer units include a 4 cm Th finishing shelf.**

H 22 1-drawer unit



hanging

**67.8** TI115Q  
**97.8** TI117Q  
**117.8** TI118Q

550  
598  
644

648  
749  
798

H 38 2-drawer unit



hanging

**67.8** TI215Q  
**97.8** TI217Q  
**117.8** TI218Q

TD215Q  
TD217Q  
TD218Q

1.000  
1.087  
1.159

1.152  
1.297  
1.376

H 43 2-drawer unit



floor sitting

**67.8** TH215Q  
**97.8** TH217Q  
**117.8** TH218Q

TP215Q  
TP217Q  
TP218Q

1.020  
1.109  
1.179

1.175  
1.321  
1.399

H 64 3-drawer unit



floor sitting

**67.8** TH315Q  
**97.8** TH317Q  
**117.8** TH318Q

1.514  
1.645  
1.740

1.728  
1.923  
2.027

H 81 4-drawer unit



floor sitting

**67.8** TH415Q  
**97.8** TH417Q  
**117.8** TH418Q

TP415Q  
TP417Q  
TP418Q

1.979  
2.150  
2.273

2.250  
2.488  
2.625

H 103 5-drawer unit



floor sitting

**67.8** TH515Q  
**97.8** TH517Q  
**117.8** TH518Q

2.474  
2.687  
2.834

2.803  
3.090  
3.253

H 120 6-drawer unit



floor sitting

**67.8** TH615Q  
**97.8** TH617Q  
**117.8** TH618Q

TP615Q  
TP617Q  
TP618Q

2.939  
3.192  
3.267

3.325  
3.655  
3.851

Materico Structure

Duna matt lacquered structure

Front  
Transparent glass  
Riflettente glass  
Trama glass

Front  
Transparent glass  
Riflettente glass  
Trama glass

## Characteristics of pull-out frames and accessories

<b>Fronts and spacers</b>	Manufactured with mdf panels or particle board panels covered with synthetic veneer. <b>Finishes:</b> Materico (Borgogna, Noce Dorato, Larice Tortora, Bon Ton, Perlage Conchiglia and Perlage Terra) or Duna matt lacquered.
<b>Pull-out frames</b>	3-sided aluminium frame painted Canna di Fucile, they are equipped with invisible galvanised metal glides, sliding rollers, automatic closing recall, stoppers, total extension and soft closing. Both in the wardrobe version and the version for drawer interior, the frames can be equipped for one of the following accessories: trouser rack, hampers, shoe rack, tray with wooden bottom, tray with glass bottom.
<b>Hampers</b>	Made of quilted fabric and Canna di Fucile painted metal rods.
<b>Shoe racks</b>	In Canna di Fucile painted folded steel sheets
<b>Trouser rack</b>	Canna di fucile painted supports and aluminium rods
<b>Wooden tray</b>	Drawer bottom made of a particle board panel covered with synthetic veneer (Borgogna, Noce Dorato, Larice Tortora, Bon Ton, Perlage Conchiglia and Perlage Terra) or Duna matt lacquered.
<b>Glass tray</b>	Transparent (Piombo) tempered glass Th. 0,6 cm
<b>Pull-out frame with accessories Solution for wardrobe structure</b>	The pull-out accessories are fixed to the wardrobe sides thanks to wooden spacers; they are equipped with a 7,9 H front

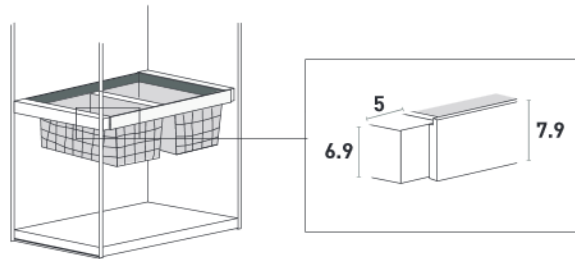



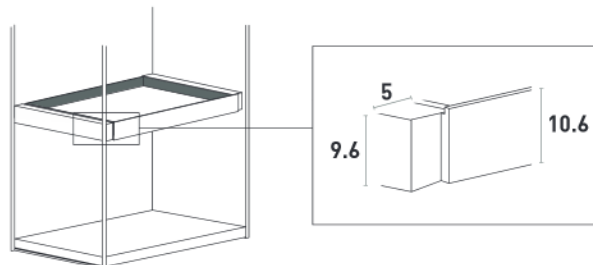

<b>Pull-out frame with tray Solution for wardrobe structure</b>	The pull-out accessories are fixed to the wardrobe sides thanks to wooden spacers; they are equipped with a 10.6 H front
---	--

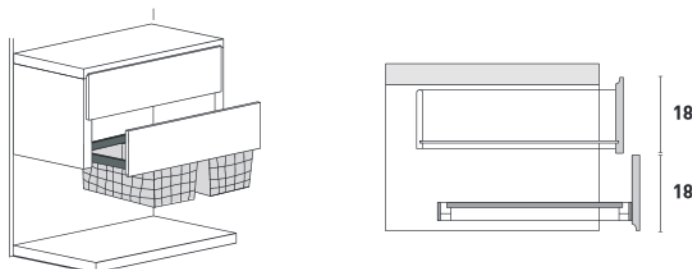

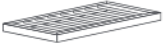
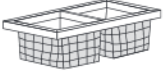
<b>Pull-out frame with accessories Solution for drawer interiors</b>	The pull-out frames are fixed to the front of the drawer in replacement of the standard wooden drawer structure. In case of hanging drawer units, only the bottom front can be equipped with the pull-out frame, as per the below drawing. The version with tray is not available. To calculate the price, add the cost of the accessories for frame to the cost of the drawer unit.
--	--



Frame with accessories	W	CODES D 59	For wardrobe structure		For drawer interior
			Materico fronts and spacers	Duna Matt lacquered fronts and spacers	Accessories
<p>Frame finish Canna di Fucile</p>					
<p>Trouser rack</p>					
					
<p>H 31 hampers made of grey quilted fabric (single hamper W 67.8)</p>					
					
<p>H 15 shoe rack in folded steel sheets</p>					
					
	67.8	62TE5*	385	424	308
	97.8	62TE7*	435	478	358
	117.8	62TE8*	474	522	397
	67.8	62TD5*	468	515	391
	97.8	62TD7*	608	670	531
	117.8	62TD8*	645	710	568
	67.8	62TF5*	544	600	468
	97.8	62TF7*	586	645	509
	117.8	62TF8*	637	700	560

Frame with tray	W	CODES D 59	For wardrobe structure		
			Materico fronts and spacers	Duna Matt lacquered fronts and spacers	
<p>Frame finish Canna di Fucile</p>					
<p>Tray with wooden bottom</p>					
					
<p>Tray with transparent Piombo glass bottom</p>					
					
	67.8	62T250	379		418
	97.8	62T270	403		444
	117.8	62T280	434		477
	67.8	62T350	408		449
	97.8	62T370	438		483
	117.8	62T380	471		510

ANTEPRIMA  
DRAWER  
UNITS  
CUBBIES  
ACCESSORIES

## Standard drawer units characteristics

### Characteristics

The structure and fronts are made of particle board panels coated and edged in synthetic finish. All drawers have an invisible guide with a galvanized metal structure, sliding rollers, automatic closing recall, anti-release stop, vertical adjust and soft closing. Guides are provided as a standard with partial extension; **upon request and with a surcharge**, guides with full extension can be supplied.

### Structure

One, two and four drawer modules are available. By stacking the modules you can build six drawer units (only under-shelf drawer units).

#### Finishes:

- Materico (Borgogna, Noce Dorato, Larice Tortora, Bon Ton, Perlage Conchiglia and Perlage Terra)
- Duna matt lacquered.

#### hanging

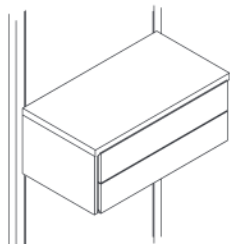

#### floor sitting

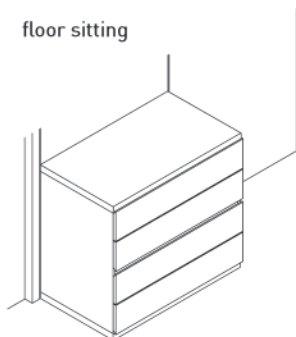

### Drawers

With 1.8 cm Th fronts in particle board, 2 cm Th fronts with inserts in synthetic leather or 2.2 cm Th fronts with glass/mirror glued directly on the particle board panel without any frame, there is a groove for opening that corresponds to the upper and lower edge of the pair of drawers. In case of a one drawer unit, the groove for opening is placed on the top side.

**The difference in thickness of the fronts does not allow drawer units with mixed wooden/synthetic leather/glass/mirror fronts to be created. We also do not recommend combinations.**

The drawer units, floor sitting, under shelf or hanging, include H 18 cm fronts with H 14 cm drawer structure. As a standard, drawer frames made of particle board panels with a grey synthetic veneer are installed.

#### Finishes:

- Materico (Borgogna, Noce Dorato, Larice Tortora, Bon Ton, Perlage Conchiglia and Perlage Terra)
- Duna matt lacquered
- Matt and glossy glass (Bianco, Piombo, Roccia and Seta as standard)
- Metallizzato glass and mirror (Argento, Bronzo and Piombo)
- Matt and glossy marble glass (Sahara, Calacatta, Amani)
- Synthetic leather (Bacca, Cactus, Creta, Elephant and Talpa).



#### Floor sitting or hanging

Drawer fronts

H 18

H 18

### Possible equipment options

**Upon request**, the bottom drawer of D 51 hanging drawer units, can be equipped with a H 5 cm metal frame painted Canna di Fucile, to be paired with one the following accessories: trouser rack, hampers or shoe rack.

**Upon request and with a surcharge**, on the top drawer of each drawer unit it is possible to install an electronic lock (please see ELECTRONIC LOCK on internal drawer units)

## Standard drawer units characteristics

### Possible solutions

Drawer units can be hanging, under shelf or free standing.

They are composed of two structural sides with thickness 1.6 cm and are modular with the back panels. If used one next to another, a 0,8 cm gap is created.

The hanging drawer units always come with a top finishing shelf. The under shelf ones are to be completed with an upper finishing shelf and a platform.

Free standing drawer units already include a finishing top and base.

Upon request and at a surcharge, free standing drawer units can be equipped with casters

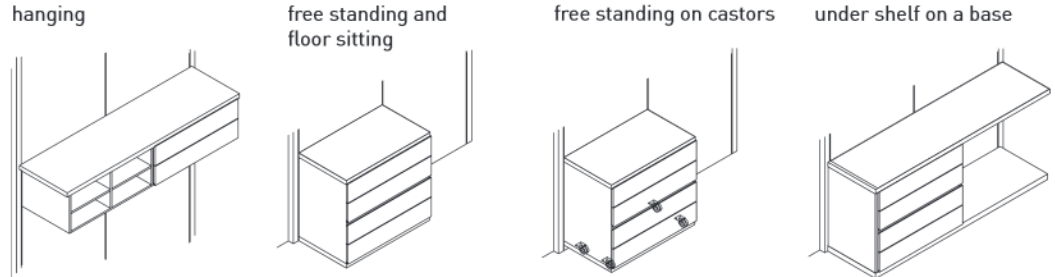

Drawer units used with shelves with visible supports **(A)** or juxtaposed with any accessories such as shelves, cubbies and hanging rods **(B)** always need structural sides of thickness 1.6 cm flush with the front. On the other hand, drawer units used with hidden supports shelves and used in an ending position with respect to the shelf to which they are fastened need a side of thickness 4 cm as a replacement for the structural side. In this case, the drawer unit is positioned flush with the shelves' side edge and consequently the drawers fall within 2.4 cm with respect to the lateral edge of the side **(C)**.

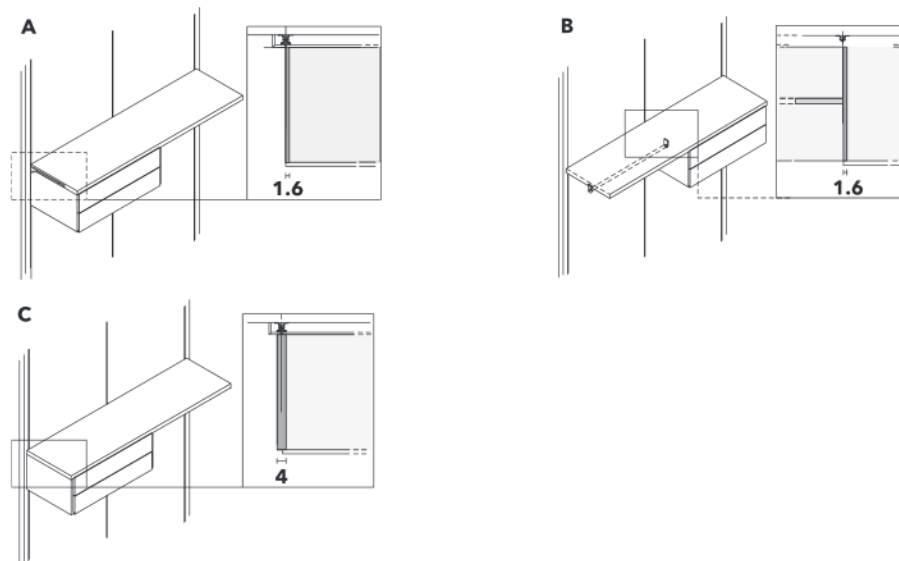

### Cubbies

Made of 1.6 Th particle board panels Eco veneered or lacquered with synthetic finish are always hanging and hooked to the shelves.

Finishes Materico (Borgogna, Noce Dorato, Larice Tortora, Bon Ton, Perlage Conchiglia and Perlage Terra) or Duna Matt Lacquered.

They are finished modules and modular with the back panels. When placed side by side a 0.8 cm space is left between the two units **(D)**.

When these elements are fixed to shelves with invisible brackets in a terminal position, they are recessed by 2.4 cm from the edge of the shelf **(E)**.

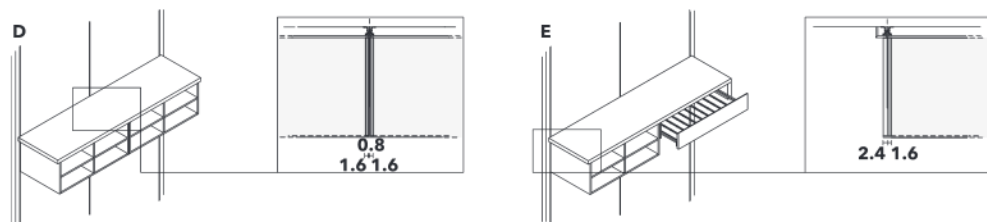



## Standard free-standing drawer units

### Extension

Partial extension included in the price  
Full extension: each drawer + €28

### Lock

Electronic lock: each + €255

H 44 2-drawer unit

### Also available for D 39.5 structure

[The code is different by one character.

E.g. T424N becomes T924N]

free standing



H 8 cm casters set

H 82 4-drawer unit

free standing



H 8 cm casters set

W CODES  
D 51

Materico Structure

Duna matt lacquered structure

Front  
Materico

Front  
Lacq.glass  
Metall.glass  
Mirror  
Synth.leather

Front  
Marble glass

Fronts  
Duna matt  
lacq.

Front  
Lacq.glass  
Metall.glass  
Mirror  
Synth.leather

Front  
Marble glass

50	T424*	277	350	403	415	428	480
70	T425*	277	350	403	415	428	480
90	T427*	350	419	483	524	513	575
110	T428*	419	509	586	629	621	698
	1RE04	63	63	63	63	63	63

50	T434*	444	590	679	666	720	809
70	T435*	444	590	679	666	720	809
90	T437*	559	699	804	838	854	959
110	T438*	661	842	968	992	1.027	1.153
	1RE04	63	63	63	63	63	63

## Standard hanging and under-shelf drawer units

### Extension

Partial extension included in the price  
Full extension: each drawer + €28

### Lock

Electronic lock: each + €255

**Hanging drawer units must always have a finishing top shelf; under shelf drawer units must always have a finishing top shelf as well as a floor sitting base.**

### H 17 1-drawer unit

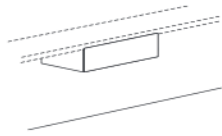

hanging

W	CODES D 51	Materico Structure			Duna matt lacquered structure		
		Front Materico	Front Lacq.glass Metall.glass Mirror Synth.leather	Front Marble glass	Fronts Duna matt lacq.	Front Lacq.glass Metall.glass Mirror Synth.leather	Front Marble glass
50	T214*	104	134	154	156	163	183
70	T215*	104	134	154	156	163	183
90	T217*	118	153	176	177	187	209
110	T218*	134	179	206	201	219	245

### H 36 2-drawer unit

#### Also available for D 39.5 structure

[The code is different by one character.  
E.g. T224N becomes T724N]

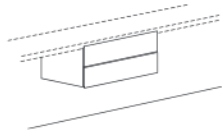

hanging

50	T224*	170	242	279	255	297	332
70	T225*	170	242	279	255	297	332
90	T227*	212	281	324	318	344	386
110	T228*	242	333	384	364	408	457

### H 36 2-drawer unit

#### Also available for D 39.5 structure

[The code is different by one character.  
E.g. T324N becomes T824N]

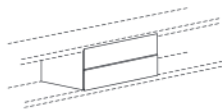

under shelf

50	T324*	185	258	297	277	314	353
70	T325*	185	258	297	277	314	353
90	T327*	225	295	340	337	360	405
110	T328*	258	347	401	386	424	476

### H 74 4-drawer unit

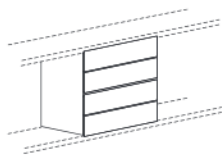

under shelf

50	T334*	352	497	573	528	607	681
70	T335*	352	497	573	528	607	681
90	T337*	434	574	660	651	700	786
110	T338*	497	681	784	746	831	934

### H 112 6-drawer unit

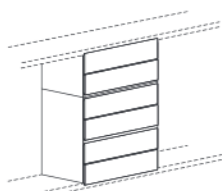

under shelf

50	T394*	556	776	894	835	947	1.064
70	T395*	556	776	894	835	947	1.064
90	T397*	678	891	1.026	1.018	1.088	1.222
110	T398*	776	1.051	1.209	1.164	1.282	1.440

## Metal drawer units characteristics and finishes

### Characteristics

The structure and fronts are made of particle board panels coated and edged in synthetic finish. All drawers have an invisible guide with a galvanized metal structure, sliding rollers, automatic closing recall, anti-release stop, vertical adjust and soft closing. Guides are provided as a standard with total extension.

### Structure

One, two and four drawer modules are available. By stacking the modules you can build six drawer units (only under-shelf drawer units).

#### Finishes:

- Materico (Borgogna, Noce Dorato, Larice Tortora, Bon Ton, Perlage Conchiglia and Perlage Terra)
- Duna matt lacquered.

#### hanging

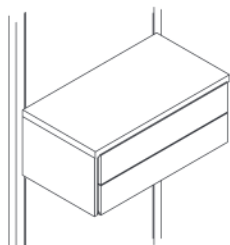

#### floor sitting

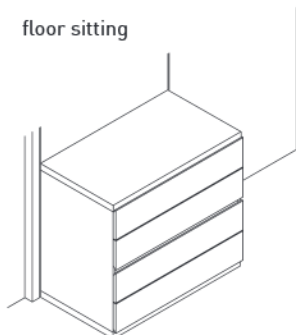

### Drawers with metal drawer frame

With 1.8 cm Th fronts in particle board, 2 cm Th fronts with inserts in synthetic leather or 2.2 cm Th fronts with glass/mirror glued directly on the particle board panel without any frame, there is a groove for opening that corresponds to the upper and lower edge of the pair of drawers. In case of a one drawer unit, the groove for opening is placed on the top side.

**The difference in thickness of the fronts does not allow drawer units with mixed wooden/synthetic leather/glass/mirror fronts to be created. We also do not recommend combinations.**

The drawer units, floor sitting, under shelf or hanging, include H 18 cm fronts.

In the metal drawer units, the whole drawer unit is composed of H 12,8 cm metal drawer frames in Canna di Fucile finish with standard total extraction and drawer bottom colour-matching the drawer units structure.

#### Finishes:

- Materico (Borgogna, Noce Dorato, Larice Tortora, Bon Ton, Perlage Conchiglia and Perlage Terra)
- Duna matt lacquered
- Matt and glossy glass (Bianco, Piombo, Roccia and Seta as standard)
- Metallizzato glass and mirror (Argento, Bronzo and Piombo)
- Matt and glossy marble glass (Sahara, Calacatta, Amani)
- Synthetic leather (Bacca, Cactus, Creta, Elephant and Talpa).



#### Floor sitting or hanging

##### Drawer fronts

H 18

H 18

### Miro drawer units with metal drawer frame and glass front

They have H 18 Th 1,8 glass fronts and Canna di Fucile aluminium frame, which has a groove for opening at the top and bottom ends of the pair of drawers. The H 12,8 cm metal drawer frame is always in Canna di Fucile finish with drawer bottom colour-matching the drawer unit's structure.

#### Finishes:

- Transparent glass (Argento, Bronzo and Piombo)
- Riflettente glass (Argento, Bronzo and Piombo)
- Trama glass (Argento, Bronzo and Piombo)

### Personalisations

**Upon request**, the drawer bottom of each individual drawer with metal drawer frames, can be customised with a different colour than the standard one; Materico for drawer units with Materico structure and Duna matt lacquered for drawer units with structure in the same finish. **With a surcharge** the following finishes are also available: Duna matt lacquered, where not standard already, or Piombo transparent glass.

### Possible equipment options

**Upon request**, the bottom drawer of D 51 hanging drawer units, can be equipped with a H 5 cm metal frame painted Canna di Fucile, to be paired with one the following accessories: trouser rack, hampers or shoe rack.

**Upon request and with a surcharge**, on the top drawer of each drawer unit it is possible to install an electronic lock, except for MIRO drawers (please see ELECTRONIC LOCK on internal drawer units)

## Metal drawer units characteristics and finishes

### Possible solutions

Drawer units can be hanging, under shelf or free standing.

They are composed of two structural sides with thickness 1.6 cm and are modular with the back panels. If used one next to another, a 0,8 cm gap is created.

The hanging drawer units always come with a top finishing shelf. The under shelf ones are to be completed with an upper finishing shelf and a platform.

Free standing drawer units already include a finishing top and base.

Upon request and at a surcharge, free standing drawer units can be equipped with casters

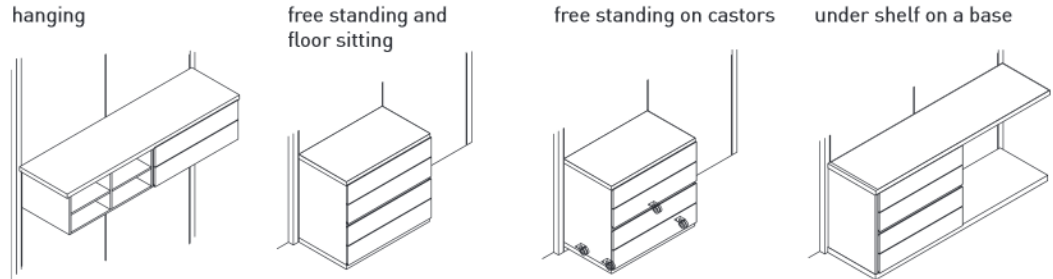

Drawer units used with shelves with visible supports **(A)** or juxtaposed with any accessories such as shelves, cubbies and hanging rods **(B)** always need structural sides of thickness 1.6 cm flush with the front. On the other hand, drawer units used with hidden supports shelves and used in an ending position with respect to the shelf to which they are fastened need a side of thickness 4 cm as a replacement for the structural side. In this case, the drawer unit is positioned flush with the shelves' side edge and consequently the drawers fall within 2.4 cm with respect to the lateral edge of the side **(C)**.

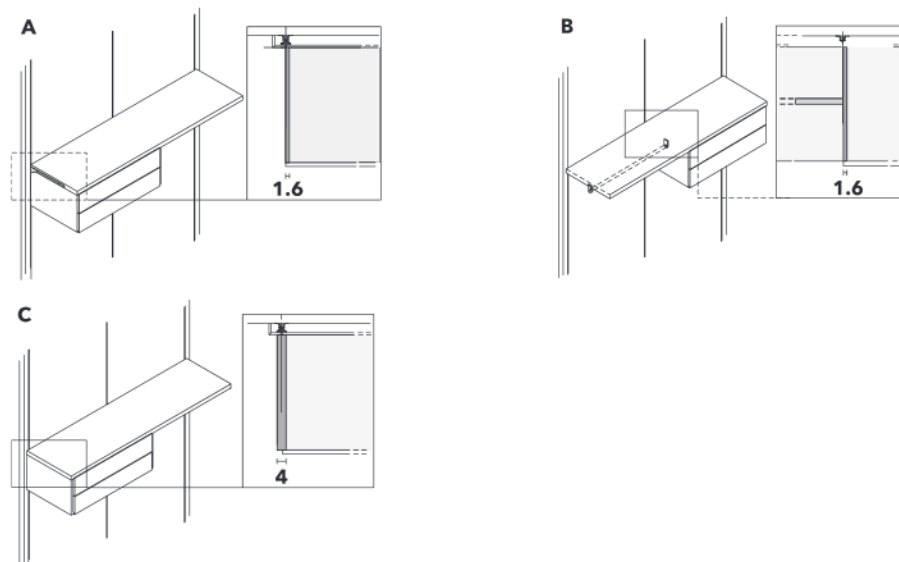

### Cubbies

Made of 1.6 Th particle board panels Eco veneered or lacquered with synthetic finish are always hanging and hooked to the shelves.

Finishes Materico (Borgogna, Noce Dorato, Larice Tortora, Bon Ton, Perlage Conchiglia and Perlage Terra) or Duna Matt Lacquered.

They are finished modules and modular with the back panels. When placed side by side a 0.8 cm space is left between the two units **(D)**.

When these elements are fixed to shelves with invisible brackets in a terminal position, they are recessed by 2.4 cm from the edge of the shelf **(E)**.

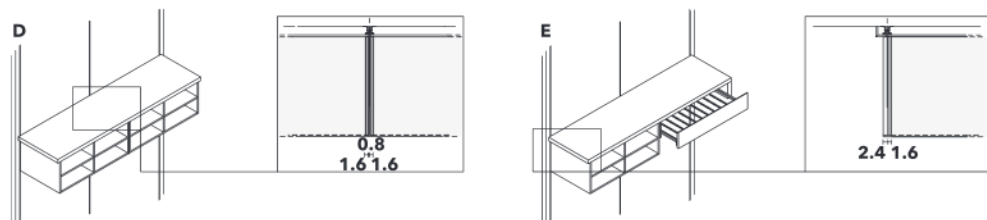

## Free standing Metal drawer units

### Extension

Full extension included in the price

### Lock

Electronic lock: each + €255

### Drawer bottom

Colour matching the structure as standard

Matt lacquered drawer bottom: each

LSGM5 + €35

Transp. Piombo glass drawer bottom: each

LSGM7 + €35

H 44 2-drawer unit

### Also available for D 39.5 structure

[The code is different by one character.

E.g. T425NM becomes T925NM]



free standing

H 8 cm casters set

H 82 4-drawer unit



free standing

H 8 cm casters set

### W CODES D 51

\*N Wooden

\*T Glass

\*P Synth.

Leather

### Materico Structure

Front  
Materico

Front  
Lacq.glass  
Metall.glass  
Mirror  
Synth.leather

Front  
Marble glass

### Duna matt lacquered structure

Fronts  
Duna matt  
lacq.

Front  
Lacq.glass  
Metall.glass  
Mirror  
Synth.leather

Front  
Marble glass

<b>70</b>	<b>T425*M</b>	815	888	941	953	966	1.018
<b>90</b>	<b>T427*M</b>	940	1.009	1.073	1.114	1.103	1.165
<b>110</b>	<b>T428*M</b>	1.047	1.137	1.214	1.257	1.249	1.326
	<b>1RE04</b>	63	63	63	63	63	63

<b>70</b>	<b>T435*M</b>	1.520	1.667	1.755	1.742	1.796	1.885
<b>90</b>	<b>T437*M</b>	1.739	1.879	1.984	2.018	2.034	2.139
<b>110</b>	<b>T438*M</b>	1.917	2.097	2.224	2.247	2.283	2.409
	<b>1RE04</b>	63	63	63	63	63	63

## Metal hanging and under-shelf drawer units

### Extension

Full extension included in the price

### Lock

Electronic lock: each + €255

### Drawer bottom

Colour matching the structure as standard

Matt lacquered drawer bottom: each LSGM5 + €35

Transp. Piombo glass drawer bottom: each

LSGM7 + €35

**Hanging drawer units must always have a finishing top shelf; under shelf drawer units must always have a finishing top shelf as well as a floor sitting base.**

H 17 1-drawer unit

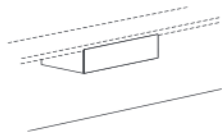

hanging

**70 T215\*M**  
**90 T217\*M**  
**110 T218\*M**

373  
413  
448

403  
448  
493

423  
471  
520

425  
472  
515

432  
482  
533

452  
504  
559

H 36 2-drawer unit

**Also available for D 39.5 structure**

[The code is different by one character.

E.g. T225NM becomes T725NM]

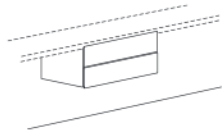

hanging

**70 T225\*M**  
**90 T227\*M**  
**110 T228\*M**

708  
802  
870

780  
871  
961

817  
914  
1.012

793  
908  
992

835  
934  
1.035

870  
976  
1.085

H 36 2-drawer unit

**Also available for D 39.5 structure**

[The code is different by one character.

E.g. T325NM becomes T825NM]

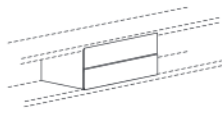

under shelf

**70 T325\*M**  
**90 T327\*M**  
**110 T328\*M**

723  
815  
885

796  
885  
975

835  
930  
1.028

815  
927  
1.014

852  
950  
1.052

891  
995  
1.104

H 74 4-drawer unit

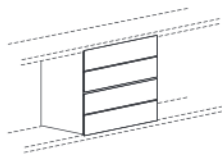

under shelf

**70 T335\*M**  
**90 T337\*M**  
**110 T338\*M**

1.428  
1.614  
1.753

1.573  
1.754  
1.937

1.649  
1.840  
2.040

1.604  
1.831  
2.002

1.683  
1.880  
2.087

1.758  
1.966  
2.189

H 112 6-drawer unit

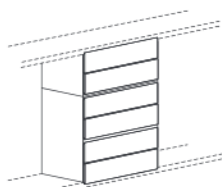

under shelf

**70 T395\*M**  
**90 T397\*M**  
**110 T398\*M**

2.171  
2.448  
2.659

2.390  
2.661  
2.934

2.508  
2.796  
3.092

2.449  
2.788  
3.047

2.561  
2.858  
3.165

2.678  
2.992  
3.323

W CODES  
D 51

\*N Wooden  
\*T Glass  
\*P Synth.  
Leather

Materico Structure

Duna matt lacquered structure

Front  
Materico

Front  
Lacq.glass  
Metall.glass  
Mirror  
Synth.leather

Front  
Marble glass

Fronts  
Duna matt  
lacq.

Front  
Lacq.glass  
Metall.glass  
Mirror  
Synth.leather

Front  
Marble glass

## Miro metal drawer units

### Extension

Full extension included in the price

### Drawer bottom

Colour matching the structure as standard  
 Matt lacquered drawer bottom: each LSGM5 + €35  
 Transp. Piombo glass drawer bottom: each LSGM7 + €35

**Hanging drawer units must always have a finishing top shelf; under shelf drawer units must always have a finishing top shelf as well as a floor sitting base.**

H 44 2-drawer unit



free standing

H 8 cm casters set

W	CODES D 51	CODES D 39.5
70	T425Q	T925Q
90	T427Q	T927Q
110	T428Q	T928Q
	1RE04	

Materico Structure	Duna matt lacquered structure
Front Transparent glass Riflettente glass Trama glass	Front Transparent glass Riflettente glass Trama glass
1.080	1.232
1.172	1.337
1.261	1.438
63	63

H 82 4-drawer unit



free standing

H 8 cm casters set

70	T435Q	
90	T437Q	
110	T438Q	
	1RE04	

2.056	2.344
2.215	2.526
2.353	2.684
63	63

H 17 1-drawer unit

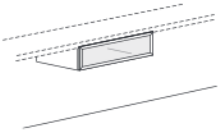

hanging

70	T215Q	
90	T217Q	
110	T218Q	

797	909
844	963
882	1.006

H 36 2-drawer unit

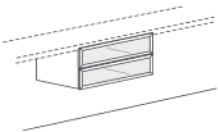

hanging

70	T225Q	
90	T227Q	
110	T228Q	

979	1.117
1.042	1.189
1.094	1.248

H 36 2-drawer unit

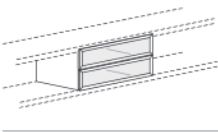

under shelf

70	T325Q	
90	T327Q	
110	T328Q	

992	1.131
1.055	1.204
1.107	1.263

H 74 4-drawer unit

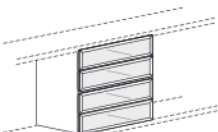

under shelf

70	T335Q	
90	T337Q	
110	T338Q	

1.969	2.245
2.096	2.390
2.200	2.508

H 112 6-drawer unit

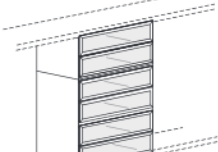

under shelf

70	T395Q	
90	T397Q	
110	T398Q	

2.980	3.398
3.171	3.616
3.324	3.792

## Hanging cubbies

Cubbies must always have a top shelf.

36 H with 2 shelves

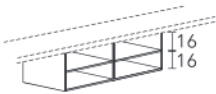

70 UA61  
90 UA71  
110 UA81

UA21  
UA31  
UA41

176  
198  
231

265  
297  
346

53 H with 2 shelves

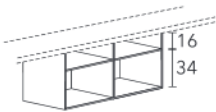

70 UA62  
90 UA72  
110 UA82

UA22  
UA32  
UA42

196  
218  
253

294  
326  
379

53 H with 4 shelves

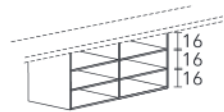

70 UA63  
90 UA73  
110 UA83

UA23  
UA33  
UA43

249  
285  
339

375  
428  
509

71 H with 4 shelves

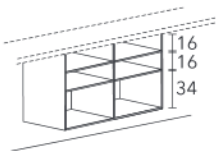

70 UA65  
90 UA75  
110 UA85

UA25  
UA35  
UA45

278  
313  
367

417  
470  
552

71 H with 6 shelves

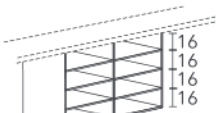

70 UA66  
90 UA76  
110 UA86

UA26  
UA36  
UA46

331  
379  
454

496  
569  
680

Structure

Materico

Duna matt lacquered



## Characteristics of pull-out frames and accessories

### Pull-out frames

3-sided aluminium frame painted Canna di Fucile, fixed directly to the drawer front instead of the standard drawer frame, they are equipped with invisible galvanised metal glides, sliding rollers, automatic closing recall, stoppers, total extension and soft closing. Both in the wardrobe version and the version for drawer interior, the frames can be equipped for one of the following accessories: trouser rack, hampers, shoe rack. In the event of drawer units with 2 or more drawers, the front that can be equipped with frame is the bottom one, as per the following drawing.

### Hampers

Made of quilted fabric and Canna di Fucile painted metal rods.

### Shoe racks

In Canna di Fucile painted folded steel sheets

### Trouser rack



Canna di fucile painted supports and aluminium rods

### Pull-out frame with accessories Solution for drawer interiors

In case of hanging drawer units, only the bottom front can be equipped with the pull-out frame, as per the below drawing.

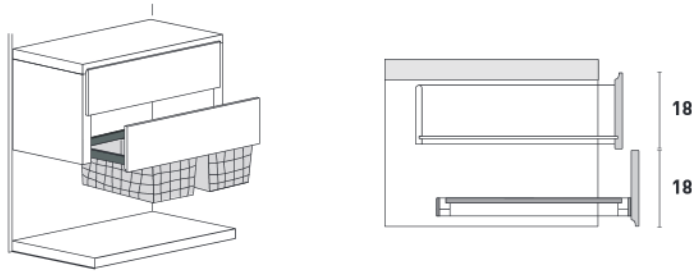
To calculate the price, add the cost of the accessories for frame to the cost of the drawer unit.

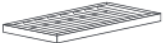
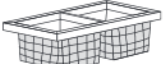

Frame with accessories	W	H	D	CODES	Accessories
<b>Frame finish</b> Canna di Fucile					
<b>Trouser rack</b>					
	70	5	51	1TZP07	308
	90	5	51	1TZP09	358
	110	5	51	1TZP0E	397
<b>Hampers</b> made of grey quilted fabric (single hamper W 69.3)					
	70	31	51	1TZQ07	391
	90	31	51	1TZQ09	531
	110	31	51	1TZQ0E	568
<b>Shoe rack in folded steel sheets</b>					
	70	15	51	1TZR07	468
	90	15	51	1TZR09	509
	110	15	51	1TZR0E	560

ISLAND

## Characteristics

### Visible back panels, tops and sides

Made of 2.2 cm Th particle board panels with synthetic veneer cover and edges that are lacquered for the lacquered version. The sides have marks for internal shelves or shoe racks are positioned at a distance of 6.4 cm from each other.

#### Finishes:

- Materico (Borgogna, Noce Dorato, Larice Tortora, Bon Ton, Perlage Conchiglia and Perlage Terra)
- Matt lacquered (smooth).

### Drawer module

The structure and fronts are made of particle board panels coated and edged in synthetic finish. The base is equipped with adjustable feet. The 0,4 cm th internal back panel is made of mdf panels.

All drawers have an invisible guide with a galvanized metal structure, sliding rollers, automatic closing recall, anti-release stop, vertical adjust and soft closing.

The drawers have 1.8 cm Th wooden fronts or 2 cm Th Synthetic Leather inserts. A groove at the top and bottom of the drawer unit front performs the handle function. The drawer units include H 18 cm fronts with H 14 cm drawer structure and guides with partial extension as standard; **upon request and with a surcharge** guides with total extension can be installed. As standard, drawer frames made of particle board panels covered with a grey veneer are installed.

In the Island module with metal drawers there are H 12,8 cm metal drawer frames in Canna di Fucile finish with standard total extraction and drawer bottom colour-matching the drawer unit's structure.

**Upon request**, the drawer bottom of each individual drawer with metal drawer frames, can be customised with a different colour than the standard one; Materico for drawer units with Materico structure and Duna matt lacquered for drawer units with structure in the same finish. **With a surcharge** the following finishes are also available for the drawer bottom: Duna matt lacquered, where not standard already, or Piombo transparent glass.

#### Finishes:

- Materico (Borgogna, Noce Dorato, Larice Tortora, Bon Ton, Perlage Conchiglia, Perlage Terra),
- Matt lacquered
- Synthetic leather (Bacca, Cactus, Creta, Elephant, Talpa).

**Upon request and with a surcharge**, on the top drawer of each drawer unit it is possible to install an electronic lock (please see ELECTRONIC LOCK on internal drawer units)

### Shelf or shoe shelf module

The structure is made of particle board panels and is coated or edged with a synthetic veneer. The base is equipped with adjustable feet. The 0.8 cm internal back panel is made of engineered wood coated with synthetic veneer. The 4 Th shelves are made of LIGHT engineered wood panels with post formed eco veneer finish on three sides or edged in eco veneer, which can be lacquered. Furthermore, the shoe shelves are complemented with MDF strips with a eco veneer finish.

**Finishes** available Materico (Borgogna, Noce Dorato, Larice Tortora, Bon Ton, Perlage Conchiglia and Perlage Terra) or Matt Lacquered (smooth).

### Glass display case

Made with 1 cm Th Argento Transparent tempered glass with 90° jointing. The strips are not tempered. It is fixed to the top by means of aluminium supports.

### Trays

Made with MDF panels covered in Synthetic Leather (Creta and Elephant).

### Specifications and price calculation instructions

In order to compose an Island module and calculate its price, it is necessary to add the price of the sides, the finishing top and any rear panel to the price of the front module.

Upon request, the Island can be supplied with a glass upper display case, with lined trays available in various configurations.

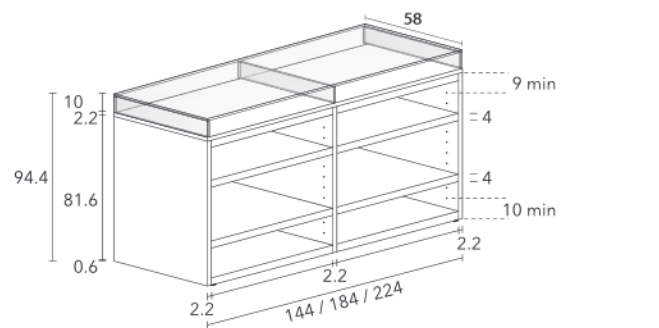
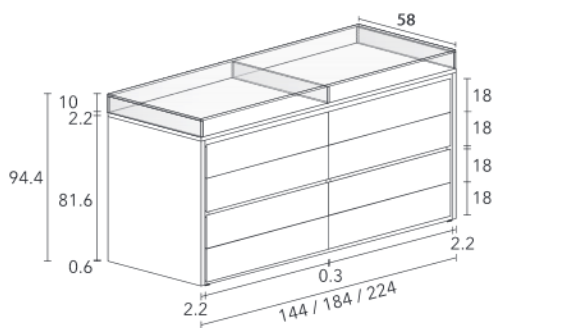
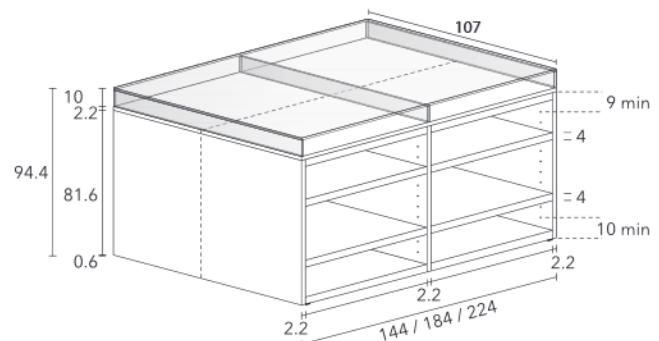
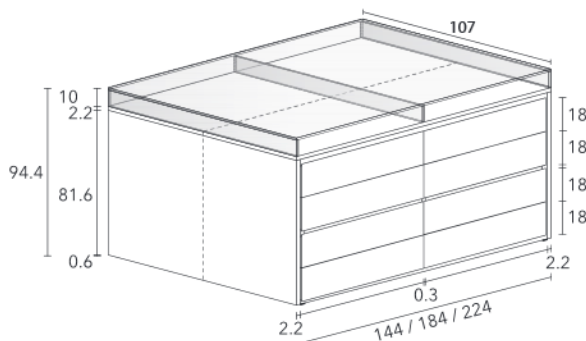

## Island

### Extension

Partial extension included in the price  
Full extension: each drawer + €28

### Lock

Electronic lock: each + €255

### Metal drawers extension

Full extension included in the price

### Drawer bottom for Metal drawer unit

Colour matching the structure as standard  
Matt lacquered drawer bottom: each LSGM5 + €35  
Transp. Piombo glass drawer bottom: each LSGM7 + €35

Finished sides and tops for half-Islands with back panels

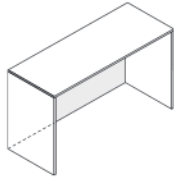

W	H	D	CODES	Materico Structure		Matt Lacquered structure	
				Front Materico	Fronts Synth.Leather	Fronts Matt lacq.	Fronts Synth.Leather
144	85	58	T6D6H	418	-	670	-
184	85	58	T6D6L	452	-	724	-
224	85	58	T6D6Q	484	-	775	-

Finished sides and tops for double-Islands

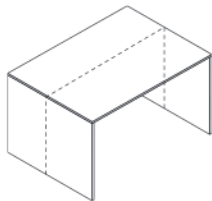

144	85	107	T6D8H	454	-	726	-
184	85	107	T6D8L	501	-	802	-
224	85	107	T6D8Q	549	-	878	-

Pair of 4-drawer units

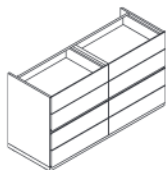

140	83	53	T63RHS	1.110	1.553	1.775	2.219
180	83	53	T63RLS	1.375	1.925	2.200	2.750
220	83	53	T63RQS	1.579	2.212	2.527	3.158

Pair of Metal 4-drawer units with customisable drawer bottom

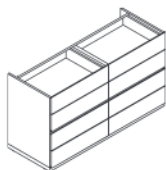

140	83	53	T63RHM	3.262	3.706	3.928	4.371
180	83	53	T63RLM	3.735	4.285	4.560	5.110
220	83	53	T63RQM	4.090	4.723	5.038	5.669

Module with shelves

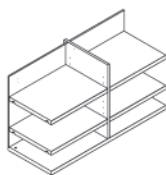

140	83	53	T678H	716	-	1.145	-
180	83	53	T678L	778	-	1.245	-
220	83	53	T678Q	888	-	1.421	-

Module with inclined shoe shelves

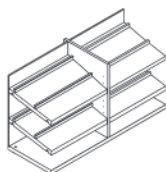

140	83	53	T6B8H	793	-	1.270	-
180	83	53	T6B8L	856	-	1.369	-
220	83	53	T6B8Q	968	-	1.549	-

# Glass display case and trays for double Island

Glass display case

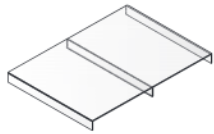

Type A double tray

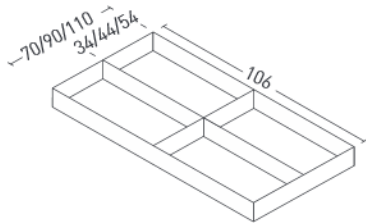

for glass case W 144  
for glass case W 184  
for glass case W 224

Type B double tray

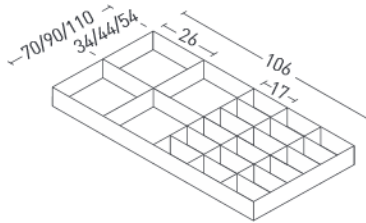

for glass case W 144  
for glass case W 184  
for glass case W 224

Type C double tray

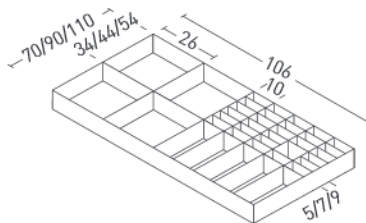

for glass case W 144  
for glass case W 184  
for glass case W 224

W	H	D	CODES	Argento transparent glass	Synthetic leather Creta Elephant
144	10	107	1D491H	959	-
184	10	107	1D491L	1.160	-
224	10	107	1D491Q	1.320	-
70	6	106	1DV987	-	566
90	6	106	1DV989	-	660
110	6	106	1DV98E	-	752
70	6	106	1DW987	-	847
90	6	106	1DW989	-	941
110	6	106	1DW98E	-	1.034
70	6	106	1DX987	-	847
90	6	106	1DX989	-	941
110	6	106	1DX98E	-	1.034

# Display case and trays for single Island

Glass display case

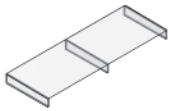

Type A single tray

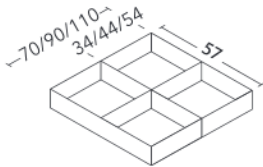

for glass case W 144  
for glass case W 184  
for glass case W 224

Type B single tray

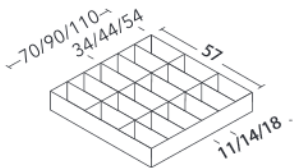

for glass case W 144  
for glass case W 184  
for glass case W 224

Type C single tray

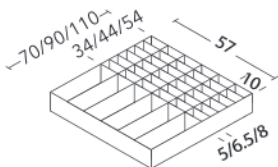

for glass case W 144  
for glass case W 184  
for glass case W 224

W	H	D	CODES	Argento transparent glass	Synthetic leather Creta Elephant
144	10	58	1D461H	855	-
184	10	58	1D461L	952	-
224	10	58	1D461Q	1.021	-
70	6	57	1DV687	-	380
90	6	57	1DV689	-	421
110	6	57	1DV68E	-	444
70	6	57	1DW687	-	587
90	6	57	1DW689	-	615
110	6	57	1DW68E	-	755
70	6	57	1DX687	-	637
90	6	57	1DX689	-	673
110	6	57	1DX68E	-	791

# ACCESSORIES

## Characteristics

<b>Bottom</b>	Made of cardboard panels with Synthetic Leather cover.
<b>Trays</b>	Made of folded cardboard panels with Synthetic Leather cover.
<b>Boxes</b>	Made of folded cardboard panels covered with Synthetic Leather and leather details with the Pianca logo.
<b>Jewellery tray</b>	Interior made with MDF panels shaped and covered in Synthetic Leather; the external tray is made with folded cardboard panels with Synthetic Leather cover.
<b>Scarf holder</b>	Interior made with MDF panels shaped and covered in Synthetic Leather; the external tray is made with folded cardboard panels with Synthetic Leather cover.
<b>Rings holder</b>	Interior made with MDF panels shaped and covered in Synthetic Leather; the external tray is made with folded cardboard panels with Synthetic Leather cover.
<b>Bracelets holder</b>	Interior made with MDF panels shaped and covered in Synthetic Leather; the external tray is made with folded cardboard panels with Synthetic Leather cover.
<b>Watches holder</b>	Interior made with MDF panels shaped and covered in Synthetic Leather; the external tray is made with folded cardboard panels with Synthetic Leather cover.
<b>Hangers</b>	Made of stained solid wood with hooks and details in black chrome and leather labels with the Pianca logo.
<b>Large ring</b>	Made of stained solid wood with hooks and details in black chrome and leather labels with the Pianca logo.
<b>Small ring</b>	Made of solid wood with leather string with the Pianca logo.
<b>Rod</b>	Made of solid wood with hooks and details in black chrome metal.

### Trays positions inside Sipario and Anteprima drawers

#### FOR STANDARD DRAWER UNIT

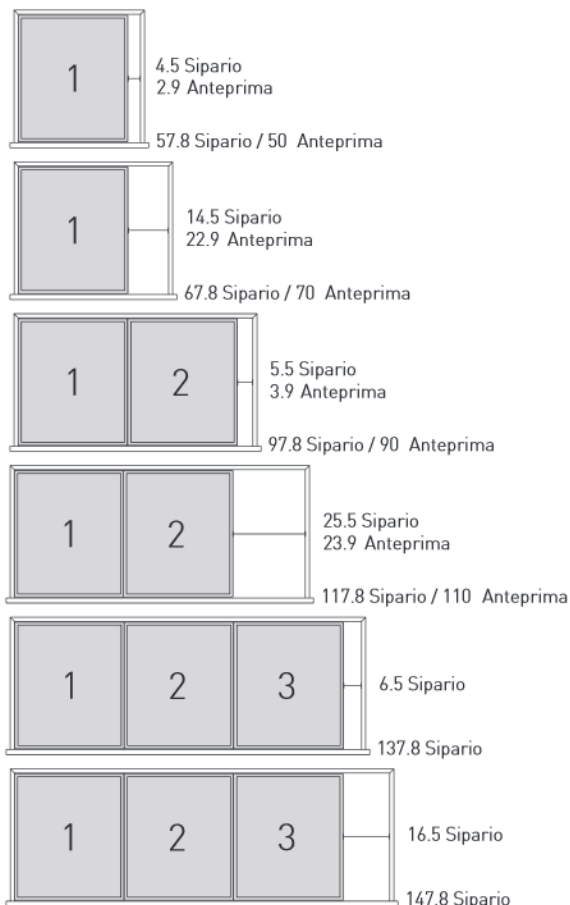



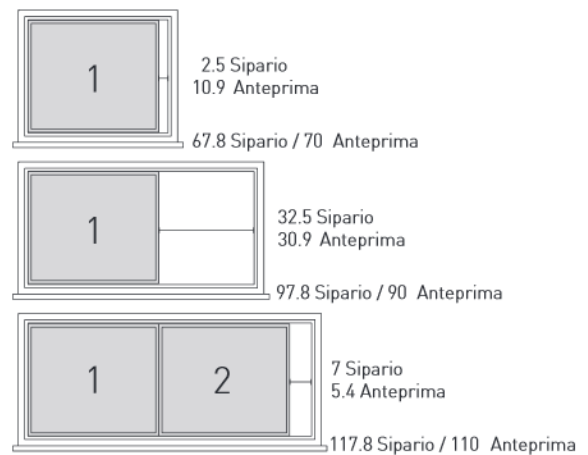



#### FOR METAL DRAWER UNIT FOR PULL-OUT TRAY FOR WARDROBE STRUCTURE



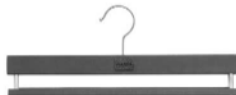
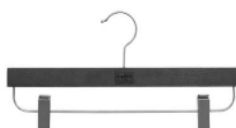

## Wooden accessories

	W	CODES	Borgogna
<p>Hanger with trouser hanger (Man) W 45 H 25 Th 5</p>  <p>4 piece set</p>		<b>62V20</b>	238
<p>Hanger with skirt hanger (Woman) W 40 H 25 Th 5</p>  <p>4 piece set</p>		<b>62V30</b>	258
<p>Trouser hanger W 39 H 16 Th 2</p>  <p>4 piece set</p>		<b>62V40</b>	190
<p>Skirt hanger W 39 H 20 Th 2</p>  <p>4 piece set</p>		<b>62V50</b>	240
<p>Small ring with leather strip for hanger tie/belt hanger W 6.5 H 16 Th 2 internal Ø 3.5</p>  <p>2 piece set</p>		<b>62V6L</b>	124
<p>Large ring for hanger scarf /bag holder W 15 H 24 Th 2 internal Ø 10.5</p>  <p>2 piece set</p>		<b>62V6M</b>	156
<p>Rod W 88</p> 		<b>62V70</b>	54

## Bottoms and boxes

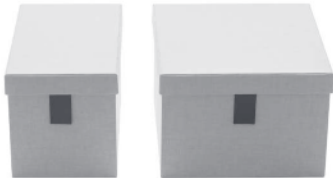
	W	CODES D 59	Synthetic leather Creta Elephant
Drawer bottoms for D 46 wooden drawers			
for Anteprema/Island	49.3	1AW2Q	39
	69.3	1AW2R	45
	89.3	1AW2S	59
	109.3	1AW2T	76
for Sipario internal drawers	57.8	62W24	39
	67.8	62W25	45
	97.8	62W27	59
	117.8	62W28	76
	137.8	62W21	80
	147.8	62W29	85
Drawer bottoms for metal drawers			
Anteprema/Island drawers	69.3	1AW4R	45
	89.3	1AW4S	59
	109.3	1AW4T	76
Sipario drawers	67.8	62W55	45
	97.8	62W57	59
	117.8	62W58	76
Boxes with lid H 26 D 48			
	26	62W7L	128
	40	62W7M	135
Boxes for cubbies			
H 14 D 51 for Anteprema	32	1AW16	122
	42	1AW17	131
	46	1AW15	131
	52	1AW18	144
H 14 D 51 for Sipario	29	62W12	122
	44	62W14	131
	54	62W15	144

## Internal accessories for drawers

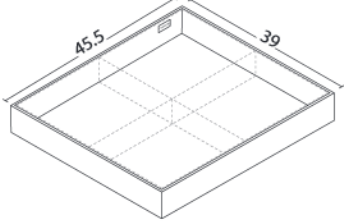
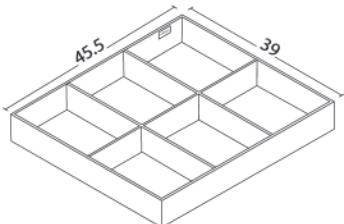
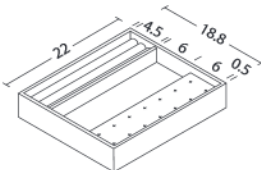
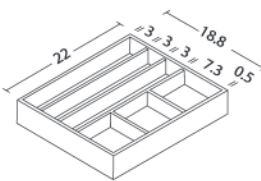
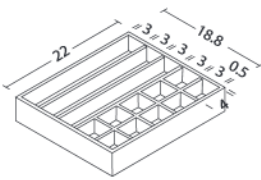
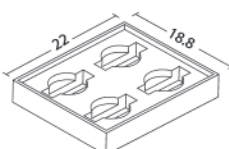
	W	CODES	Synthetic leather Creta Elephant
<p>H 6 D 39 Tray (can contain up to 4 trays for accessories W 22 P 18,8)</p> 	45.5	62W43	101
<p>Tray with grille H 6 D 39 with scarf/ties/belts holder</p> 	45.5	62W63	168
<p>Tray with rings holder H 4 D 18,8</p> 	22.1	62W4A	168
<p>Tray with jewelry holder H 4 D 18,8</p> 	22.1	62W4B	168
<p>Tray with bracelets holder H 4 D 18,8</p> 	22.1	62W4C	168
<p>Tray with watches holder H 4 D 18,8</p> 	22.1	62W4D	168

**PIANCA**

Via dei Cappellari, 20  
31018 – Gaiarine, Treviso  
ITALY

T +39 0434 756911  
F +39 0434 75330

info@pianca.com  
pianca.com

p.iva IT 01682580269

Vietata la riproduzione a qualsiasi scopo.

Campione promozionale gratuito non destinato alla vendita.

Escluso iva art.2 comma 3 D.P.R. 633/72 - esonerato da documento di trasporto art.4 punto 6  
D.P.R. 621/78

Pianca si riserva di apportare, senza preavviso, le modifiche necessarie al fine di migliorare il  
funzionamento e la qualità dei propri prodotti.

Si prega di consultare i listini e relativi aggiornamenti per aspetti tecnici e dimensionali.

Colori e materiali hanno valore puramente rappresentativo.

**EN** Pianca reserves the right to apply the necessary modifications without notice, in order to  
improve the performance and quality of its products. Please see the pricelists and relevant  
updates for technical data and dimensions. Colours and materials serve merely as an  
example.



N.B22FLA2T

